



  PRODUCT
CATALOGUE



ABOUT US

Who are We?

HornerXpress® Worldwide is the world's largest independent distributor of swimming pool and spa products. Part of the Team Horner™ family of companies established in 1969, our culture and commitment to our customers have led to long term business relationships in over 100 countries worldwide.

Pioneering our first international branch in Pune, India, HornerXpress® India Pvt Ltd. was launched on March 29, 2017 to better serve the local business communities across the country. Our excellent relationships with our manufacturing suppliers, as well as our impressive stock of inventory and daily delivery service, provide us with the ability to ensure first-rate order fulfillment whenever and wherever needed.

What do We do?

We offer an extensive range of quality watershaping products from the world's leading manufacturers, including our sister companies, AquaCal® Heat Pumps, AutoPilot® Salt Chlorine Generators, and Lo-Chlor® Specialty Chemicals. We can supply whatever you need for creating and maintaining world-class swimming pools and spas. Some of our exclusive company brands include AquatiX Pool Products, BackyardXpo Outdoor Living Xperience, StoneHardscapes Natural Stone Pavers and Veneer and TileXpressions Swimming Pool Tile.

Why Choose HornerXpress® India?

As a leading wholesale distributor, our growing team of industry professionals are committed to promoting the growth of the swimming pool industry while offering complete business solutions. Our goal is to help the long-term growth and success of our customers, providing premium innovative products, and superior service and support. We're here for you, supplying what you need, when you need it, at competitive prices.



WELCOME

To the World of Team Horner™



Our constant focus throughout the decades has been to create "Win – Win" business strategies with companies like yours! Our commitment and team dedication are to provide you the very best products, prices, and services so you can be successful in your local marketplace.

HornerXpress® truly has a global perspective, with long time relationships in over 100 countries worldwide. Our group of companies includes four manufacturing businesses, AquaCal® Heat Pumps, AutoPilot® Salt Chlorine Generation Systems, Lo-Chlor® Specialty Chemicals and Piscines Provence Polyester fiberglass pools. Thanks to our thriving Wholesale Distribution business, with 16 locations inside the United States, we have strong relationships and the best pricing with virtually all of the key American manufacturers of swimming pool and spa equipment.

We look forward to working together, growing together, and winning together!

Mike Dooley
President & COO

Dr. Bill Kent
Chief Executive Officer

Working Together...

Growing Together...

Winning Together...

CONTACT US

Pune Office:

Gat No-118/1, Gaikwad Wasti, Pune -
Nashik Highway, Near Ajinkya Hotel,
Chimbali, Tal - Khed, Dist Pune
412105 Maharashtra, India

P: (+91) 2135-261048/49

M: (+91) 98470-41383

Bangalore Office:

Bldg. No. 38, Sai Nilaya, Flat S-5, 2nd Cross
Deshbandhu Nagar, Vidyanarayapura
560097 Bangalore, India

P: (+91) 9900-002919

Email: hxindia@teamhorner.com

Website: hxindia.com

USA Corporate Office:

5755 Powerline Road
Fort Lauderdale, FL 33309 USA

P: (+1) 954-938-5355

Email: hxworldwide@teamhorner.com

Website: hxworldwide.com



One Company... One Team

teamhorner.com

hornerxpress.com

hxworldwide.com

hxindia.com

aquacaloreu.com

piscines-provence-polyester.com

aquacal.com

autopilot.com

jbfittings.com

lo-chlor.com

tropiclear.com

backyardxpo.com

stonehardscapes.com

tileexpressions.com

CONTENTS



6 *AquaCal® Heat Pumps*

22 *AutoPilot® Salt Chlorine Generators*

30 *Lo-Chlor® Specialty Chemicals*

34 *TropiClear® Maintenance Chemicals*

38 *StoneHardscapes*

42 *AquatiX Pool Products*

59 *Vendor Partners*





AquaCal® is the largest heat pump manufacturer for pools and spas in the world. Since 1981, it has been our sincere belief that providing you with quality products and standing behind those products is our only path to success. We are the leader in our industry and have more pool and spa heat pumps installed than any of our competitors. We are committed to quality. Every unit is 100% tested before it leaves the factory. We have used our experience in the industry to provide you with products that represent today's leading heat pump technology.

With our state-of-the-art Research and Development facility, and our fully-staffed Engineering department, we can assure you that our products will perform as designed - Guaranteed! We will continue to provide you with the best performing, highest-quality products for many years to come. With our unbeatable warranty that you receive with your AquaCal® heat pump, you are assured the best quality heat pump money can buy. This is just one way of expressing, to our valued customer, the commitment to excellence at Team AquaCal®.



 **MADE IN USA** 

How a HEAT PUMP Works

Heat is transferred from the air to the swimming pool



1 Warm air is drawn over the evaporator coil by the fan, transferring heat to the COLD refrigerant liquid passing through it.

2 Warm refrigerant gas passes through the compressor and becomes HOT refrigerant gas.

3 HOT refrigerant gas transfers heat to the pool water as it passes through the heat exchanger.

4 The now COLD refrigerant liquid passes back to the evaporator coil to collect more heat.



Why Choose AquaCal®?

- Corrosion-proof cabinet
- Industry-leading warranty periods
- PAN India after-sales service coverage and support
- Energy efficient
- Dual thermostats
- Offset plumbing
- Manufacturing since 1981
- SuperQuiet operation with HeatWave SuperQuiet® series
- Patented ThermoLink® titanium heat exchanger
- Design & engineering expertise

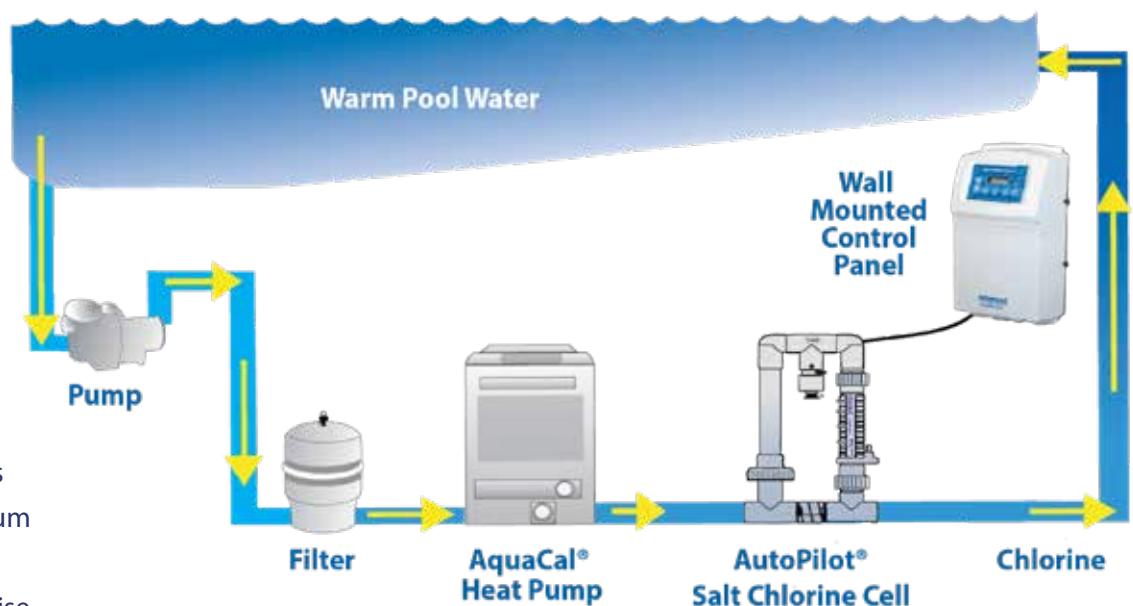



Titanium heat exchanger patented counter-flow water management system

- The ThermoLink® Heat Exchanger tube is made from titanium, and is virtually impervious to water chemistry damage.
- Only ThermoLink® Titanium technology uses a patented water management system that maximizes surface contact of pool water with our Titanium Heat Exchanger.
- This patented hydraulic design adds only 2 PSI at 10.2 m³/hr, increasing compatibility with two-speed & variable speed pumps.
- AquaCal® heat pumps featuring ThermoLink® Titanium technology offer you maximum strength, durability and performance.

**NEW
FLIP-OUT DIGITAL
CONTROL PANEL**



AquaCal® Heat Pumps

HEATWAVE SUPERQUIET

A heat pump uses nature's 'free heat' from the air to heat pool water. It applies the same principle used in air conditioners with technology adapted to pools & spas. The IceBreaker® units can also cool pool water in hot summer months.

FEATURES

- Advanced microprocessor control with 24 character full-text display provides easy-to-read menu options & unit status, and is protected against sun and weather
- Unique AquaTop protects internal components from weather & debris while ensuring optimal air flow
- Ability to connect to most external controllers for heating & cooling mode
- Hybrid functionality can initiate a gas heater when an extra boost of heat is needed
- Continues to heat in freezing temperatures to minimize heat loss & shorten heat recovery time
- Set to heat, cool or autotemp
- PoolSync™ ready: Adjust the mode to heat, cool or autotemp (when applicable), and set your temperature through the PoolSync app*



*Additional purchase of PoolSync WiFi Controller required

SPECIFICATIONS

HeatWave SuperQuiet® Model		SQ145	SQ225	SQ120R	SQ166R
Efficiency	kW Output	29.3	35.2	25.8	31.7
	BTU Output	100,000	120,000	88,000	108,000
	C.O.P. Coefficient of Performance	6.8	6.5	5.5	5.6
	kW Input	4.3	5.4	4.7	5.7
Electrical	Heat or Heat & Cool	H	H	H & C	H & C
	Voltage/Hz/Phase	H & D	D	H & D	D
H - 200-240/50/1 D - 380-420/50/3	Max. Fuse Size	H - 60 D - 20	D - 25	H - 60 D - 20	D - 25
	Min. Circuit Ampacity	H - 38.9 D - 14.2	D - 16.2	H - 38.9 D - 14.2	D - 16.2
Refrigerant		R410A	R410A	R410A	R410A
Water Flow	Min./Max. (m³/h)	6.8/15.9	6.8/15.9	6.8/15.9	6.8/15.9
A Heater Bypass Kit is required when flow rates exceed the maximum					
Physical	Weight (kg)	141	143	132	141
	Length x Width x Height (cm)	87 x 87 x 112	87 x 87 x 112	87 x 87 x 112	87 x 87 x 112
Shipping	Weight (kg)	159	162	150	159
	Length x Width x Height (cm)	94 x 92 x 130	94 x 92 x 130	94 x 92 x 130	94 x 92 x 130

Specifications subject to change - please visit www.aquacal.com for current specifications

Heating Charts

50 Hz

- High test point temperature
- Low test point temperature
- 63% Relative humidity/26.7°C water temperature
- 80% Relative humidity/26.7°C water temperature



AquaCal® Heat Pumps

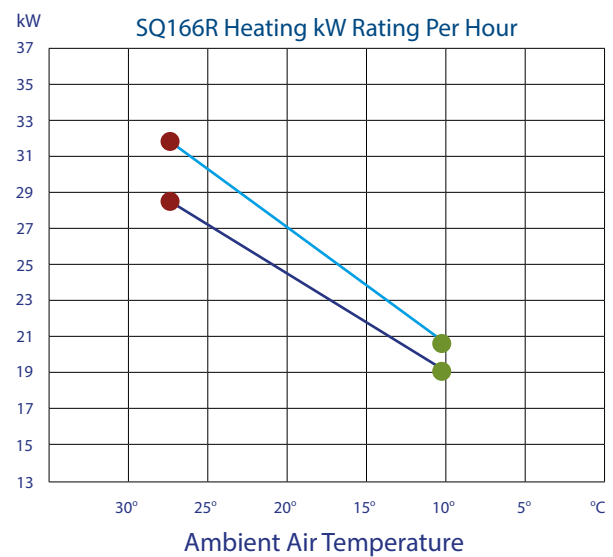
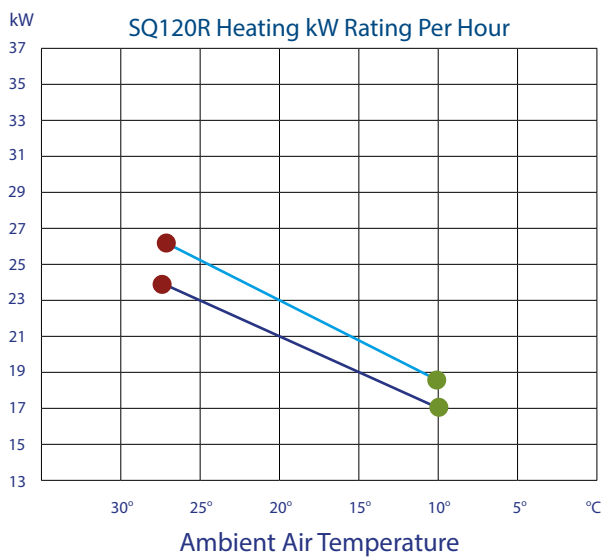
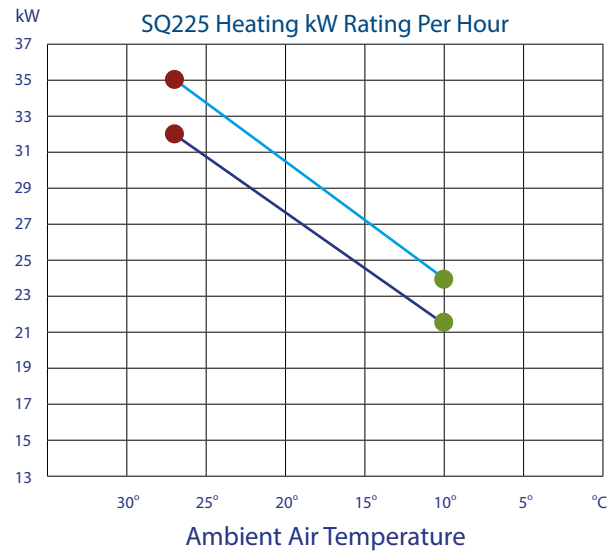
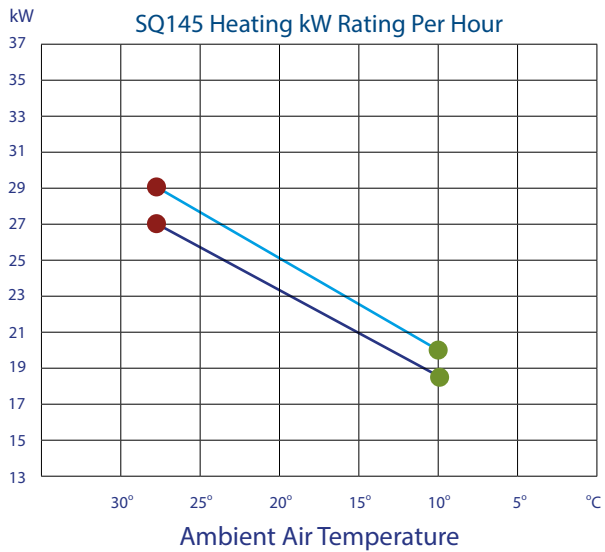

Specifications subject to change

AquaCal® Heat Pumps

HEATWAVE SUPERQUIET™ VARIABLE SPEED

AquaCal's advanced variable speed heat pump technology will automatically adjust its speed, precisely matching the heating demand to maximize efficiency.

FEATURES

- Variable speed smart technology cuts heating costs up to 40% more than a single speed heat pump
- The investment of the Variable Speed Heat Pump versus a single speed heat pump can be recouped in energy savings in less than 3 years
- C.O.P.'s can reach as high as 10.5 or higher
- High performance titanium heat exchanger
- ICEBREAKER® Heat & Cool - Heats spas on the coldest nights, extends swimming season longer than heat only models and cools the water as desired
- PoolSync™ ready: Adjust the mode to heat, cool or autotemp, and set your temperature through the PoolSync app (PoolSync included)



SPECIFICATIONS

HeatWave SuperQuiet®	Model	SQ150VS
Efficiency @6,000 RPM	kW Output	33.7
	BTU Output	115,000
Efficiency @3,500 RPM	kW Output	21.1
	BTU Output	72,000
	C.O.P Coefficient of Performance	9.3
	kW Input	2.3
Refrigerant		R410A
Electrical H - 200-240/50/1	Heat or Heat & Cool	H & C
	Voltage/Hz/Phase	H
	Max. Fuse Size	H - 60
	Min. Circuit Ampacity	H - 47
Over Temperature Alarm Kit available: part number STK0221 for single phase. Strongly recommended for all spa applications.		
Water Flow	Min./Max. (m³/h)	6.8/15.9
A Heater Bypass Kit is required when flow rates exceed the maximum		
Physical	Weight (kg)	136
	Length x Width x Height (cm)	87 x 87 x 112
Shipping	Weight (kg)	154
	Length x Width x Height (cm)	94 x 92 x 130
Rated outside the scope of AHRI Standard 1160 - Specifications subject to change		

Output Data

Ratings at 50 GPM and 26.7°C Air/80% Relative Humidity/26.7°C Water

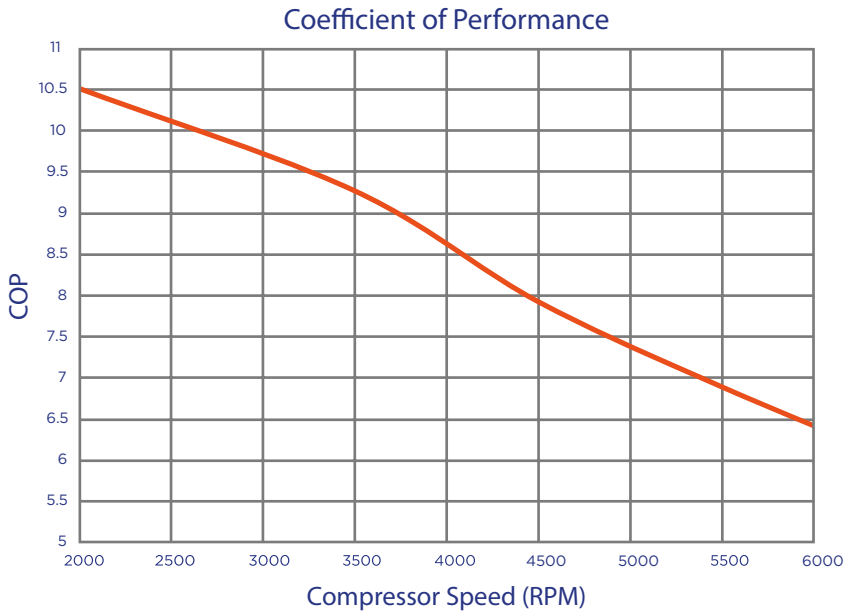

AquaCal® Heat Pumps

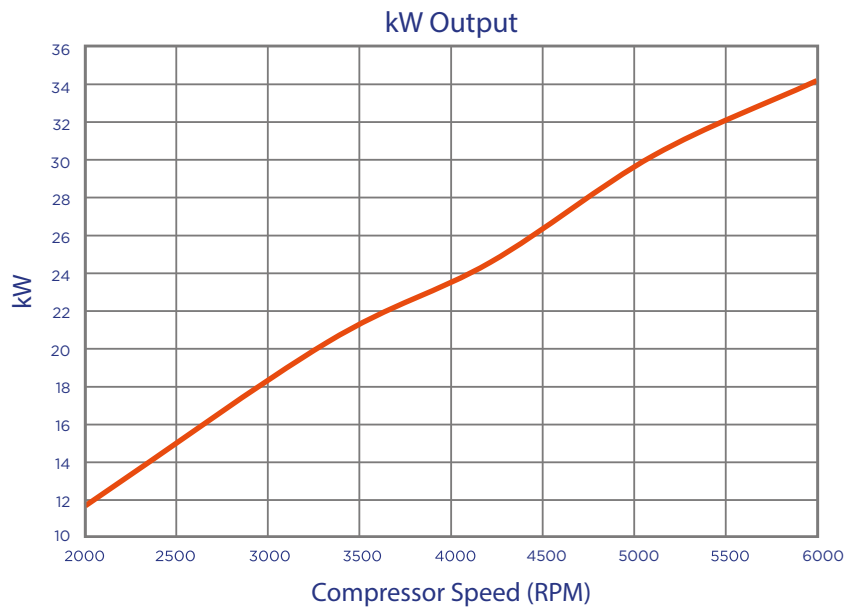

Specifications subject to change

AquaCal® Heat Pumps



The TropiCal® is a quality heat pump designed to fit any budget. Perfect for aboveground pools and inground pools.

FEATURES

- High performance titanium heat exchanger
- Flip-out, lockable control panel with 24 character full-text display provides easy-to-read menu options and unit status, and is protected against sun and weather
- Hybrid functionality can initiate a gas heater when an extra boost of heat is needed
- Built in drain pan provides condensate management
- Automatic defrost
- Impact resistant, rust and fade proof cabinet
- PoolSync™ ready: Adjust the mode to heat, cool or autotemp (when applicable), and set your temperature through the PoolSync app*



*Additional purchase of PoolSync WiFi Controller required

SPECIFICATIONS

Heat & Cool Units

TropiCal®		Model	T35R	T55R	T75R	T115R	T135R
Efficiency	kW Output		9.3	12.6	21.5	26.8	30.0
	BTU Output		32,000	43,000	73,000	91,000	102,000
	C.O.P. Coefficient of Performance		5.5	6.0	7.7	6.9	6.8
	kW Input		1.7	2.1	2.8	3.9	4.4
Electrical	Voltage/Hz/Phase		H	H & D	H & D	H & D	D
	Max. Fuse Size		H - 20	H - 25 D - 10	H - 35 D - 15	H - 60 D - 25	D - 25
H - 200-240/50/1 D - 380-420/50/3	Min. Circuit Ampacity		H - 13.0	H - 16.1 D - 7.6	H - 20.3 D - 10.1	H - 38.6 D - 15.2	D - 17.2
Refrigerant			R410A	R410A	R410A	R410A	R410A
Heat Exchanger			Tube in Tube	Tube in Tube	Tube in Tube	ThermoLink®	ThermoLink®
Water Flow	Min./Max. (m ³ /h)		4.5/10.2	4.5/10.2	4.5/10.2	6.8/15.9	6.8/15.9
A Heater Bypass Kit is required when flow rates exceed the maximum							
Physical	Weight (kg)		81	91	96	121	122
	Length x Width x Height (cm)		87 x 87 x 72	87 x 87 x 72	87 x 87 x 72	87 x 87 x 100	87 x 87 x 100
Shipping	Weight (kg)		99	109	114	139	140
	Length x Width x Height (cm)		94 x 92 x 87	94 x 92 x 87	94 x 92 x 87	94 x 92 x 115	94 x 92 x 115

Specifications subject to change - please visit www.aquacal.com for current specifications

Heating Charts

50 Hz

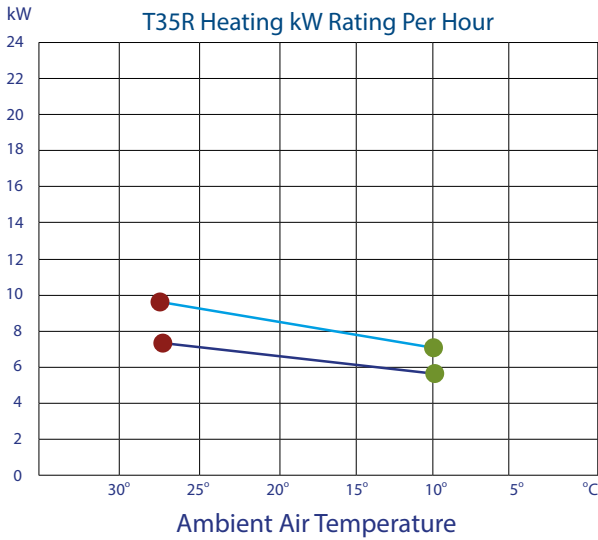

- High test point temperature
- Low test point temperature
- 63% Relative humidity/ 26.7°C water temperature
- 80% Relative humidity/26.7°C water temperature

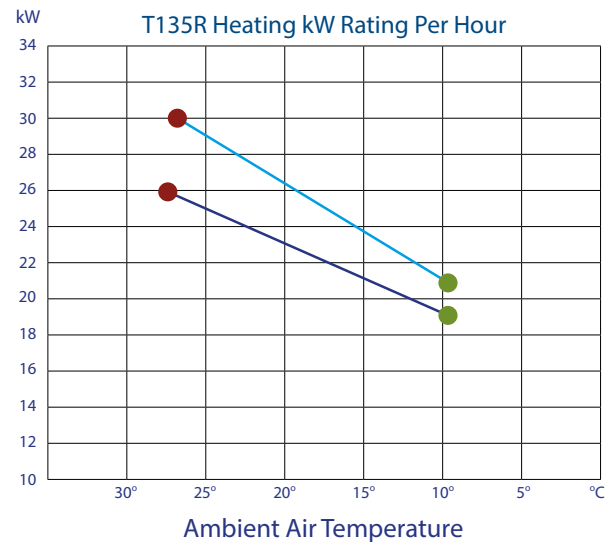
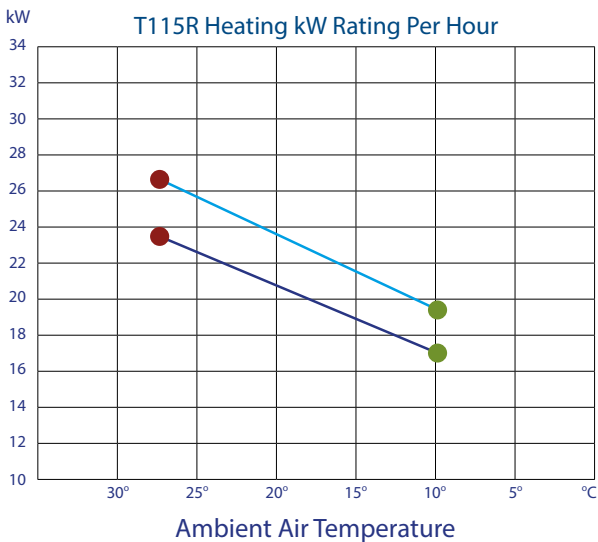
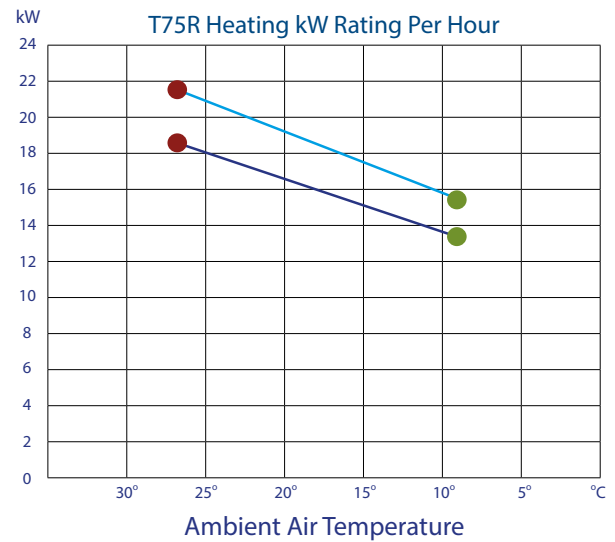
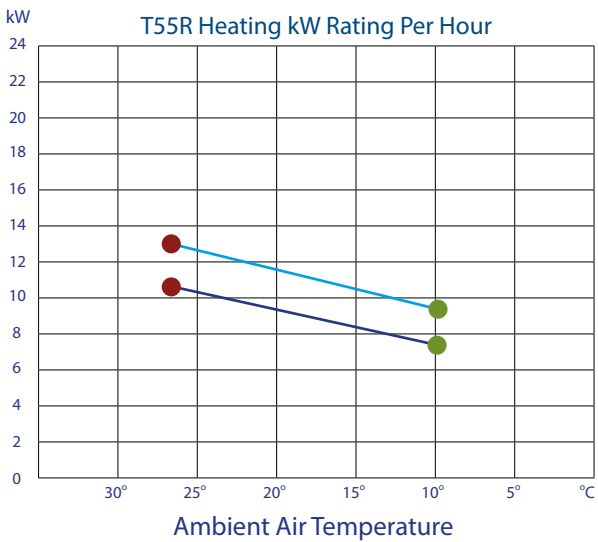

Specifications subject to change

AquaCal® Heat Pumps



The TropiCal® T170R is a quality heat pump designed to fit any budget. Perfect for aboveground pools and inground pools.

FEATURES

- High performance patented ThermoLink® titanium heat exchanger
- Lockable control panel with 24 character full-text display provides easy-to-read menu options and unit status
- Hybrid functionality can initiate a gas heater when an extra boost of heat is needed
- Automatic defrost
- Impact resistant, rust and fade proof cabinet
- PoolSync™ ready: Adjust the mode to heat, cool or autotemp, and set your temperature through the PoolSync app*



*Additional purchase of PoolSync WiFi Controller required

SPECIFICATIONS

TropiCal®	Model	Heat & Cool Unit	
		T170R	
Efficiency	kW Output	48	
	BTU Output	164,000	
	C.O.P. Coefficient of Performance	6.7	
	kW Input	7.2	
Electrical	Voltage/Hz/Phase	D	
	Max. Fuse Size	D - 35	
	Min. Circuit Ampacity	D - 22	
D - 380-420/50/3		Over Temperature Alarm Kit available: part number STK0221 for single phase, STK0222 for three phase. Strongly recommended for all spa applications	
Refrigerant		R410A	
Heat Exchanger		ThermoLink®	
Water Flow	Min./Max. (m ³ /h)	6.8/15.9	
A Heater Bypass Kit is required when flow rates exceed the maximum: part number STK0135			
Physical	Weight (kg)	148	
	Length x Width x Height (cm)	89 x 92 x 106	
Shipping	Weight (kg)	164	
	Length x Width x Height (cm)	98 x 116 x 127	

Specifications subject to change - please visit www.aquacal.com for current specifications

Heating Chart

50 Hz

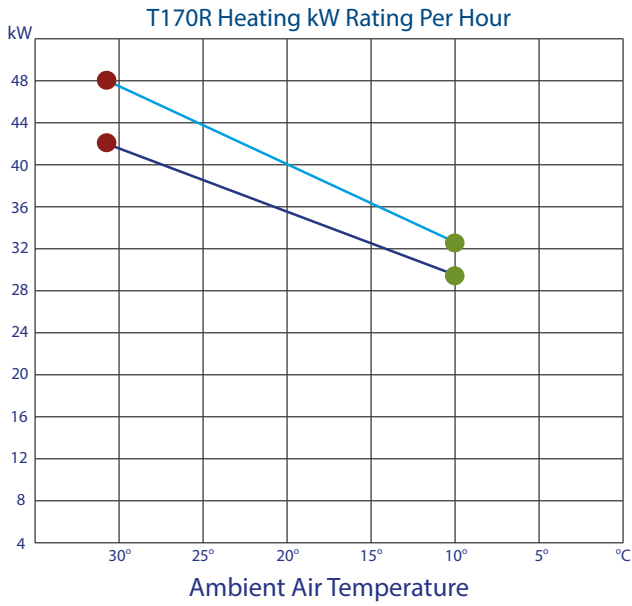

- High test point temperature
- Low test point temperature
- 63% Relative humidity/ 26.7°C water temperature
- 80% Relative humidity/26.7°C water temperature



AquaCal® Heat Pumps

Specifications subject to change



AquaCal® Heat Pumps



AquaCal® Heat Pumps

High performance aero-thermal heating and cooling for commercial applications.

FEATURES

- ThermoLink® titanium heat exchanger patented counter-flow water management system
- Whisper-Quiet fan motors
- Heat and Cool standard on GBB
- Super-efficient SCROLL compressor
- Electronic control & monitoring system
- Extends heating season in any climate
- Electrostatic painted cabinet
- Continues to heat when temperatures drop below freezing
- Dual Plumbing Configuration allows for convenient & easy installation
- PoolSync™ ready: Adjust the mode to heat, cool or autotemp, and set your temperature through the PoolSync app*



*Additional purchase of PoolSync WiFi Controller required

SPECIFICATIONS

Great Big Bopper®	Model	BB500
Performance/Heating		
@26.7°C Air/80% RH/ 26.7°C Water	kW Output	123.7
	BTU Output	422,000
	C.O.P. (Coefficient of Performance)	6.8
	kW Input	18.1
@10°C Air/63%RH/ 26.7°C Water	kW Output	73.3
	BTU Output	250,000
	C.O.P. (Coefficient of Performance)	4.1
	kW Input	17.9
Performance/Chilling		
@37.8°C Air/26.7°C Water	kW Absorption	91.3
	BTU Absorption	311,516
	kW Input	21.2

Electrical	Voltage/Hz/Phase	380-415V/50Hz/3ph
	Min. Circuit Ampacity	58.0
	Recommended Fuse Size	80
	Max. Fuse Size	80
Over Temperature Alarm Kit available: part number STK0221 for single phase, STK0222 for three phase. Strongly recommended for all spa applications		
Pool Water Flow	Min./Max. (l/min)	454/1059
	Pressure Drop/Pool Water @568 l/min	0.12 bar
	Pool Water Connections	4" U.S.
Refrigerant		R410A
Physical	Weight (kg)	700
	Length x Width x Height (cm)	229 x 138 x 219
Shipping	Weight (kg)	953
	Length x Width x Height (cm)	232 x 148 x 219

Specifications subject to change - please visit www.aquacal.com for current specifications

Heating Chart

50 Hz

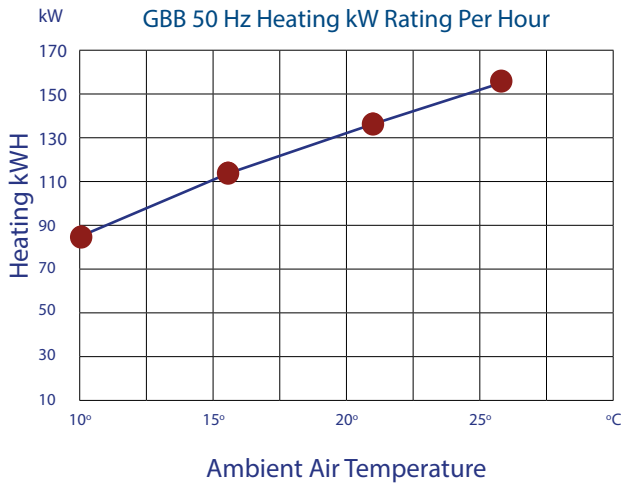

AquaCal® Heat Pumps

Chilling Chart

50 Hz

- Air Temp °C
- 10°
 - 15°
 - 21°
 - 26°
 - 32°
 - 37°
 - 45°

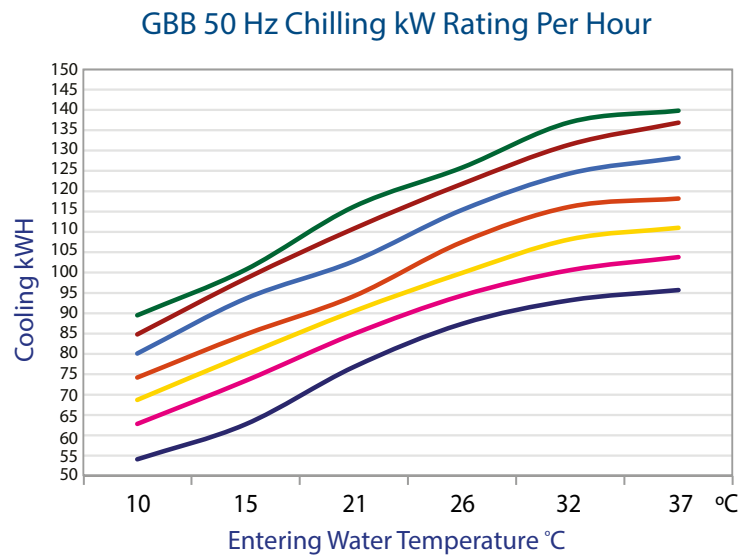

Specifications subject to change

AquaCal® Heat Pumps



The TropiCool® Water Chiller is designed to lower the temperature of your pool or plunge pool to an enjoyable experience throughout the summer. A heat pump gives you consistent performance, while evaporative cooling systems struggle to keep up in humid climates.

FEATURES

- Set the desired temperature to maintain
- Very quiet operation
- Helps conserve water, does not work on evaporation
- Consistent performance regardless of humidity
- Titanium heat exchanger impervious to harsh water chemistry
- Ability to chill as low as 4.4°C for cold plunge pools
- TC500 for cold plunge up to 7,500 L
TC1000 for cold plunge up to 11,300 L
TC1500 for cold plunge up to 15,000 L
- PoolSync™ ready: Set your temperature through the PoolSync app*



*Additional purchase of PoolSync WiFi Controller required

SPECIFICATIONS

TropiCool®	Model	TC500	TC1000	TC1500
Electrical	Voltage/Hz/Phase	H	H	H
	H - 200-240/50/1			
	Max. Fuse Size	H - 35	H - 60	H - 60
	Min. Circuit Ampacity	H - 20.3	H - 38.6	H - 38.9
Water Flow	Min./Max. (m³/h)	4.5/10.2	6.8/15.9	6.8/15.9
Physical	Weight (kg)	91	118	149
	Length x Width x Height (cm)	87 x 87 x 72	87 x 87 x 100	87 x 87 x 112
Shipping	Weight (kg)	110	134	161
	Length x Width x Height (cm)	97 x 92 x 84	97 x 92 x 110	97 x 92 x 125

Specifications subject to change - please visit www.aquacal.com for current specifications

50 Hz Model Selection Guide for Most Climates

Optimum Expected Temperature Drop

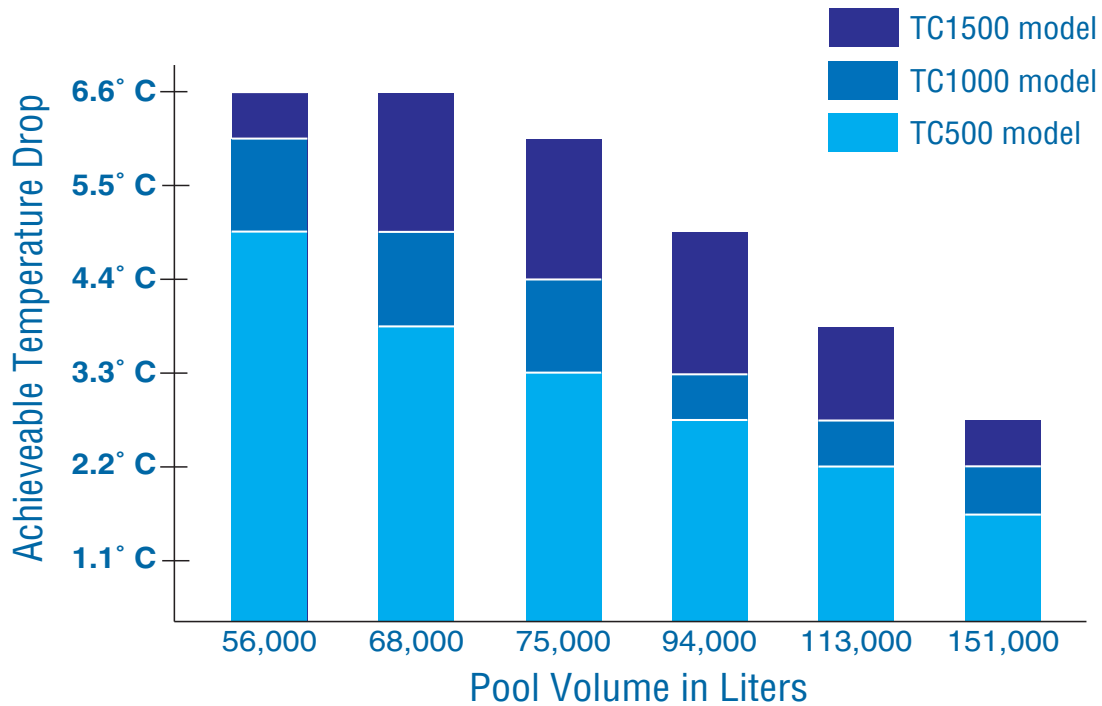

Extreme climates with consistent excessive temperatures may experience the need for extended runtimes (up to 24 hours), larger units or multiple units.



AUTOPILOT®

SALT CHLORINE GENERATORS

AutoPilot® Salt Chlorine Generators

In production since 1976, AutoPilot® Salt Chlorine Generator units have been proven over time. With over a half million satisfied customers worldwide, only AutoPilot® offers you the combination of quality, dependability, customer satisfaction and warranty... insist on the BEST... the ORIGINAL, AUTOPILOT®.

AutoPilot® has been the technological leader in the chlorine generation process for swimming pools for many years. AutoPilot® sets the standard for reliability, features and performance... and has a unit to fit every need and budget. Salt chlorine generators produce a constant low

level of chlorine right in the pool's plumbing. This creates superior water quality and drastically reduces the need to monitor and add other balancing and maintenance chemicals.

AutoPilot® offers a wide range of product line, from a simple unit for aboveground pools, to the most technologically advanced Digital unit, to a combination unit that marries the power of Ozone with the convenience of salt chlorine generation. AutoPilot® even offers commercial units for larger applications.



HOW DOES A SALT CHLORINE GENERATOR WORK?

IT'S SALT...NATURALLY

Salt is natural. It is also economical and available everywhere. Salt is environmentally friendly and its conversion is energy efficient. When the salt passes through the AutoPilot® cell, it is converted to chlorine. After sanitizing the pool water, it turns back into salt, and the process begins all over again.

The best part is that the salt is at a much lower level than even contact lens solution, so there is no 'salty' taste to the water.



Electrolysis separates the molecules. We use the Cl (chlorine) and then it recombines back to NaCl (salt).

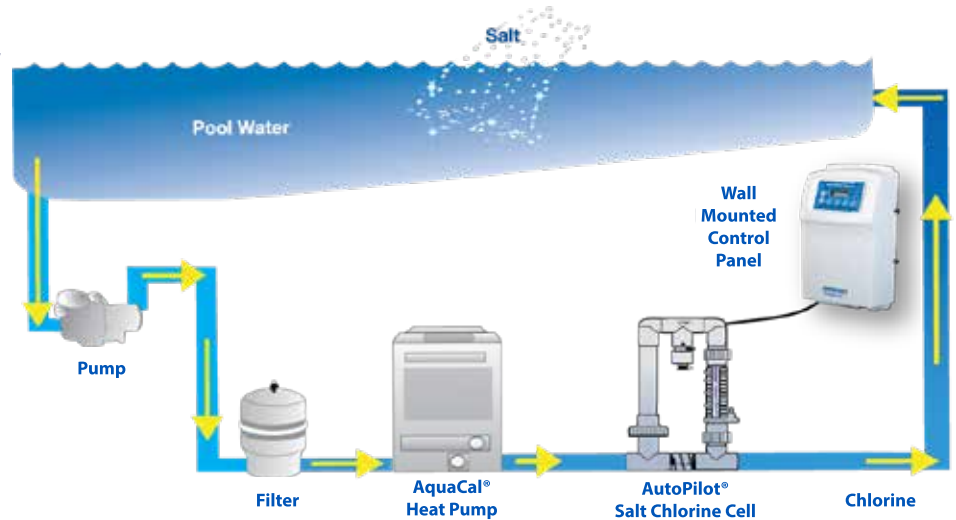

AutoPilot® Salt Chlorine Generators

Pool Pilot® NANO & NANO +PLUS

Crystal clear pool water everyday... The natural way.
Packed with features for residential applications.

FEATURES

- Nano+ maintains pools up to 121 m³
- Nano maintains pools up to 106 m³
- Patented temperature compensation
- 24 & 72 hour boost cycles
- Operates at all salt levels - 2 to 35 g/L
- Operates in water up to 40°C
- Push button controls
- Digital readout display English, Spanish, French, Italian, Czech or German

Replacement Cells: PPC1 for Nano, PPC2 for Nano+



Ref. #	Description	Chlorine Output (at 3,500 ppm salt)	Maximum Pool Size
DN2	Digital Nano 220V with PPC1 Manifold	16.5 g/h	106 m ³
DNP2	Digital Nano+ 110/220V with PPC2 Manifold	21.0 g/h	121 m ³

Patented Bypass Manifold



- 1-Inline strainer
- 2-Tri-sensor
- 3-Chlorine production cell
- 4-Check valve

Nano/Nano+ Control Panel



Digital Display Readout:

- Salt level
- Water temperature
- Amount of salt to add
- Diagnostics

AutoPilot® Salt Chlorine Generators

Smartest salt chlorine generator in the world!

FEATURES

- Microprocessor technology
- Extra bright Vacuum Fluorescent Display (VFD)
- Patented temperature compensation 24 & 72 hour boost cycles
- Operates at all salt levels 2 to 35 g/L
- Operates at any water temperature up to 40°C
- Soft reverse cell cleaning
- Optional time clock controls pool pump
- Choice of 4 cells to suit pool size
- Patented bypass manifold for optimum chlorine production
- Digital readout displays English, Spanish, French, Italian or German

Replacement Cells: PPC1, PPC3, PPC4 and PPC5



Ref. #	Description	Chlorine Output (at 3,500 ppm salt)	Maximum Pool Size
DIG-220CE	Digital Power Supply 110/220V CE		
PPM1M	Manifold with PPC1 Cell with Metric Adaptors	25.5 g/h	151 m ³
PPM3M	Manifold with PPC3 Cell with Metric Adaptors	31.5 g/h	189 m ³
PPM4M	Manifold with PPC4 Cell with Metric Adaptors	38.5 g/h	227 m ³

Patented Bypass Manifold



- 1-Inline strainer
- 2-Tri-sensor
- 3-Chlorine production cell
- 4-Check valve

Pool Pilot® Digital Control Panel



Digital Display Readout:

- Salt level
- Water temperature
- Amount of salt to add
- Diagnostics

COPILOT³ OZONATOR

THE STRONGEST TEAM IN POOL WATER SANITATION

The convenience of salt chlorination with the power of ozone destroys up to 99.99% of microorganisms in the pool, offering superior sanitation and water clarity.



Recommended for pools up to 208 m³



Recommended for pools up to 379 m³



Ref. #	Description	Maximum Pool Size
COADN2PPC1SUS	Digital Nano 110/220V with CoPilot & PPC1 Cell	208 m ³
COBDIG2PPC4SUS	DIG-220 110/220V with CoPilot XL & PPC4 Cell	379 m ³

Ozone is nature's most powerful oxidizer

Ozone destroys pathogens, microorganisms and organic contaminants quicker than any other alternative pool sanitation method. It kills bacteria, viruses, molds, cysts, yeasts & mildew, including cryptosporidium & giardia. Yet, it is environmentally friendly. Ozone takes care of the bulk of the sanitizing load but a residual is still required in the pool.

Combine with Pool Pilot® for maximum benefits

Ozone reduces the need for chlorine by 60-90%. This allows the Pool Pilot® to simply maintain the chlorine residual in the pool, extending the cell life. Our patented manifold allows for easy installation and temperature compensation.

The strongest team in pool water sanitation because...

- Most effective, natural way to maintain clean, clear pool water
- Water feels luxuriously soft & silky
- Promotes swimmers health & safety
- Reliable and energy efficient
- Environmentally friendly
- No chemical byproduct
- Requires little maintenance
- Next generation ozone units with integrated Advanced Plasma Gap technology

Pool Pilot® Professional

Pool Pilot® Professional offers not just a trouble-free pool, but water that is luxurious to swim in.

FEATURES

- Perfect for commercial installations
- Eliminate chlorine storage
- Improve indoor air quality
- Each power supply controls up to six cells (convection or in-line configuration)
- Special commercial cells, self-cleaning with soft reverse assures longer life and reduced maintenance
- Up to 7.1 kg per day of pure chlorine output
- Temperature compensated output assures constant level of production
- Digital panel monitors independent cell performance
- Compatible with ORP controllers



7.1 kg/day



Ref. #	Description
PR02EU	Professional Power Supply, 2 Power Boards with 2 Commercial Cells
PR03EU	Professional Power Supply, 3 Power Boards with 3 Commercial Cells
PR04EU	Professional Power Supply, 4 Power Boards with 4 Commercial Cells
PR05EU	Professional Power Supply, 5 Power Boards with 5 Commercial Cells
PR06EU	Professional Power Supply, 6 Power Boards with 6 Commercial Cells



Pool Pilot® PRO WC SERIES

REDUCE MAINTENANCE & INCREASE SATISFACTION

The Pool Pilot® Professional WC Series offers the convenience and safety of onsite chlorine generation for any commercial pool.

BENEFITS

- Improves air quality by eliminating chloramines and other nasty chlorine effects
- Salt is environmentally friendly and its conversion is energy efficient
- Long lasting system lowers the cost of operation
- Pool water feels luxuriously soft and silky



FEATURES



POWER SUPPLY

- Models range from 151 to 529 g/h of chlorine production per day
- Large LCD indicates salinity, cell volts, water temperature, output setting, etc.
- Notifications for low salt, water temperature, flow, etc.
- Precision torodial salt sensor never needs calibration
- Automated salinity control capability
- Industrial grade, water-cooled, switched-mode power supply
- Input control can be used with a chemical feed controller or in manual operation

CELL

- Patented single cell technology
- Normal operating range of 3,500 - 5,000 mg/L salt
- Self-cleaning (reversing) 15,000-hour cell electrode stack
- Clear reaction chamber for easy visual inspection
- 4 mm plate spacing designed for commercial applications
- Only 4.54 m³/h flow required



SPECIFICATIONS

POWER SUPPLY

	PROA8	PROA11	PROA14	PROB17	PROB22	PROB28
Dimensions H x W x D (cm)	56 x 66 x 31	56 x 66 x 31	56 x 66 x 31	56 x 66 x 31	56 x 66 x 31	56 x 66 x 31
Physical Weight (kg)	27.2	27.2	27.2	32.7	32.7	32.7
Electrical Input - Vac	208-240	208-240	208-240	208-240	208-240	208-240
Phases	1	1	1	1	1	1
Frequency - Hz	50/60	50/60	50/60	50/60	50/60	50/60
Current Input - Amps	7.5	7.5	7.5	15	15	15
Fuse Size - Amps	20	20	20	20	20	20
GFCI Breaker - Amps	20	20	20	30	30	30

CELL

	PROA8	PROA11	PROA14	PROB17	PROB22	PROB28
Dimensions H x W x D (cm)	69 x 28 x 28	69 x 28 x 28	69 x 28 x 28	69 x 28 x 28	69 x 36 x 36	69 x 36 x 36
Physical Weight (kg)	15.9	17.2	18.1	18.6	25.4	27.2
Chlorine Production - (g/h)*	151.2	207.9	264.6	321.3	415.8	529.2
Rated Pressure - psi (kPa)	50 (345)	50 (345)	50 (345)	50 (345)	50 (345)	50 (345)
Minimum Flow Rate (m ³ /h)	4.54	4.54	4.54	4.54	4.54	4.54
Inlet Diameter (cm)	2.54	2.54	2.54	2.54	3.81	3.81
Outlet Diameter (cm)	2.54	2.54	2.54	2.54	3.81	3.81

*based on 5,000 mg/L of Salt

INSTALLATION

- Multiple cell installations require the cells to be plumbed in parallel (not in series).
- Each cell housing is plumbed using a bypass to achieve the 4.54 g/h of flow required to meet the rated chlorine production.
- The power supply water-cooling lines are plumbed from the return line to the pump suction using 3/8" tubing. If a chemical feed controller is being used then the same tubing line can be used for both.

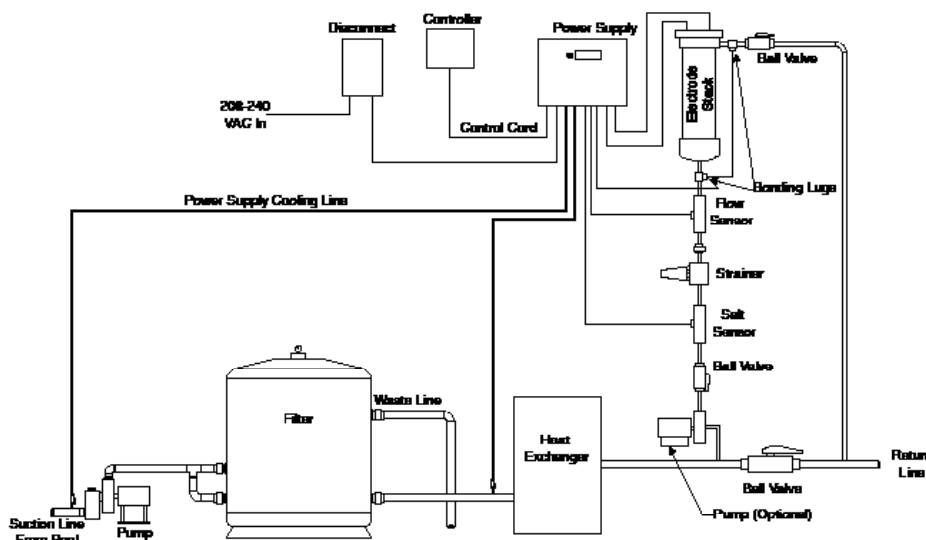



Lo-Chlor's unique formulations consistently excel in the toughest year-round environment for pool maintenance and they have been doing so for over 40 years. Humidity, heat, and year-round sunshine make for an algae paradise. The sun's intense UV rays decompose chlorine. Shoreline winds and sudden weather changes blow in seeds, insects, sand and dirt. Tropical storms can dump foliage, outdoor furniture, trash... basically anything into our pools.

Lo-Chlor Specialty Pool Chemicals are specifically designed to target the pool water problems that maintenance chemicals alone cannot resolve.

Lo-Chlor LLC, is proud to manufacture these exclusively developed products in the USA at our Fort Lauderdale, FL based facility.

A trusted name in performance pool chemicals, Lo-Chlor premium pool products are highly effective, rigorously lab tested and all competitively priced. We create and optimize our formulas while being kind to the environment. That means your pool water will be cleaner, clearer and safer, leaving you with peace of mind.

It's easy. Remember, the best solution is "The Proven Solution"...Lo-Chlor!



ALGAE CONTROL



90-Day Algicide

- Lasts for 3 months
- Effective against blue-green, black and mustard algae
- Safe for all pool finishes
- Guaranteed non-staining formula

Size: 946 mL, 3.78 L, 18.9 L, 208 L*



Lo-Phos® Max

- Eliminates phosphates quickly
- Maximum strength
- Minimizes pool maintenance
- Compatible with all pool chemicals
- Reduces chlorine demand

Size: 946 mL, 3.78 L, 18.9 L, 208 L*



Lo-Phos® E+

- Powerful enzymes break down contaminants
- Removes oils & scum lines
- Reduces skin & eye irritation
- Reduces chlorine demand
- Removes phosphates
- Maintenance usage can remove up to 500 ppb phosphates weekly

Size: 946 mL, 18.9 L, 208 L*

WATER & HEAT CONSERVATION



Aqua Blanket™

- Invisible barrier dramatically reduces evaporation in summer, heat loss in winter
- Extends the swim season & saves money
- Conserves water & energy
- Safe, non-toxic, biodegradable, odorless
- Compatible with all sanitizing methods

Size: 473 mL, 946 mL, 3.78 L, 208 L*



Leak Sealer

- Seals minor leaks in most swimming pools and spas
- Use in pools losing up to 1 inch of water per day
- No need to drain pool or spa
- Fast acting - usually works in 24 hours
- Great for sealing new pool builds & repairs

Size: 946 mL, 208 L*

IMPROVE WATER CLARITY

Knockdown®

- High performance non-alum flocculant
- Contaminants drop to pool bottom for easy vacuuming
- Cleans and clears pool water – contains a clarifier
- Effective over a wide pH range
- Use with all sanitizer types
- Won't affect water balance
- Works with all pool surfaces

Size: 946 mL



Miraclear® Blue

- Keeps pool water crystal clear
- Improves filter efficiency
- Non-toxic & biodegradable
- More concentrated than competitive products
- One of our top-selling products

Size: 946 mL, 3.78 L, 208 L*



Miraclear® Clarifier Tab

- Super concentrated clarifying gel tab
- Keeps water sparkling for 30 days
- Does not affect water chemistry
- Non-toxic & biodegradable
- Convenient to use, no measuring
- Just drop in the skimmer basket

Size: 57 m³ or 114 m³



“The PROVEN Solution” for your pool water challenges

STAIN SOLUTIONS



Multi-Stain Remover

- Removes iron, copper, manganese & organic stains
- Exceptionally concentrated, triple-strength formula
- Works quickly – usually within 24 hours
- Renews & brightens older, dull concrete finishes
- Safe for all pool surface types

Size: 0.9 kg



Chlor-Nix®

- Lowers chlorine & bromine levels
- Fast acting
- Perfect for reducing chlorine shock
- Ideal for use with Multi-Stain remover

Size: 454 g, 3.63 kg, 22.68 kg



Metal Gone

- Sequesters metals in solution, keeps stains off of pool surfaces
- Use weekly as a safeguard against staining
- Regular use aids in scale prevention
- Works with all pool finishes and surfaces

Size: 946 mL, 3.78 L, 208 L*

FastStart-Tech®

- Problem-free start-ups
- Advanced formula controls plaster dust
- Powerful sequestrant prevents metal stains & scale
- Yields no phosphates

Size: 946 mL, 208 L*



ELIMINATE TILE SCUM LINES & FILTER LOAD

Ultra Zyme Pro®

- For COMMERCIAL POOLS, high bather load
- Powerful, broad spectrum enzyme formulation
- Reduces chlorine demand by 30%
- Breaks down organic debris, reduces maintenance time & effort
- Noticeably improves cycle time
- Extends filter cycle time

Size: 946 mL, 3.78 L, 18.9 L, 208 L*



Ultra Zyme®

- Powerful, broad spectrum enzyme formulation
- Reduces demand for chlorine & other chemicals
- Breaks down organic debris
- Eliminates scum lines
- Safe, non-toxic, biodegradable
- Compatible with chlorine generators

Size: 946 mL

PERFORMANCE ENHANCER

EZ•Pour Stabilizer

- Reduces chlorine loss from UV rays
- Dissolves instantly, protects immediately
- Professional strength
- Ready to use
- Safe and effective for ALL chlorine types and salt pools
- Non-acidic formula is gentle on all pool surfaces

Size: 3.78 L



Filter & Tile Cleaner

- Super non-acidic cleaner
- Quickly degrease cartridge filters & D.E. grids
- Great on BBQ grills, patio furniture, tubs & sinks
- Use full-strength; no mixing or pouring
- Convenient quart bottle with spray nozzle
- Spray or soak cleaning method

Size: 946 mL, 18.9 L, 208 L*



* All 208 L drums include a pump and 12 empty, labeled bottles



lo-chlor.com **LO-CHLOR**





TropiClear® has been in the Swimming Pool industry since 1969 and is a qualified authority in the treatment of pool and spa water. TropiClear® chemicals are concentrated and designed to provide the pool owner with excellent value year after year, unlike low grade, less concentrated products found in many mass-market retailers.

TropiClear® stands for **dependable** and **dazzling** quality pool care products at affordable prices.

Thousands of pool and spa owners rely on TropiClear® pool chemicals to help them maintain healthy, perfectly balanced, crystal clear water. TropiClear® chemicals are only sold through authorized professional pool and spa retailers or Service companies.

See for yourself and try our products today!

TropiClear® Maintenance Chemicals

ALGAECIDES

Algaecides are chemical treatments designed to kill algae and prevent new algae growth. Algae spores are airborne so rain and debris introduce algae to pool water, and sunlight and warm weather allow it to flourish.

Sizes Available

Black Algae Destroyer	0.9 kg	4.5 kg	22.7 kg
Yellow Eliminator	0.17 kg	0.9 kg	11.34 kg
No More Troubles®	946 ml	3.78 L	



BALANCERS

Balancers help regulate water quality to protect all pool surfaces. Proper water balance is key to achieving pool water that is safe and healthy for swimmers and equipment.

Sizes Available

Stabilizer	0.79 kg	1.8 kg	3.6 kg
Calcium Hardness Treatment	1.8 kg	3.6 kg	6.8 kg
Alkalinity Control	2.3 kg	4.5 kg	
pH Plus	2.3 kg	4.5 kg	
pH Minus	4.5 kg		



SANITIZERS

Sanitizers are necessary for maintaining safe and healthful pool water. They're used to kill and prevent bacteria, viruses, algae and other organic contaminants that enter your pool by way of wind, rain, dust and swimmers.

Sizes Available

3" Jumbo Tabs *	0.79 kg	2.18 kg	3.57 kg	6.95 kg	11.31 kg	22.62 kg
Super Shock (Cal Hypo)	0.45 kg	2.27 kg	11.34 kg	22.68 kg	45.36 kg	
Granular Dichlor	0.9 kg	4.53 kg	22.67 kg			
Multi-Tabs	6.8 kg	11.34 kg	22.67 kg			
8 oz. Chlorinating Sticks	11.34 kg	22.67 kg				
Quick Dissolving Shock	0.45 kg					

*3" Jumbo Tabs are also available Unwrapped



SPECIALTIES

Specialties are chemicals developed to solve specific pool needs. From time to time pools need special attention. Specialty products will get your pool back to its clear, stable and safe condition.

Sizes Available

4 in 1 Clarifier	946 ml		
Defoamer	946 ml		
Filter Cleaner	946 ml		
Metal Out	946 ml		
Tile & Vinyl Brite	946 ml		
Ultra Blue Clarifier	946 ml		
Super Duty Tile Soap	3.79 L		
Oxidizing Shock & Swim	0.45 kg		
Skum Remover	946 ml	3.79 L	18.927 L



Pool Salt
Size: 18.1 kg

*Not all products shown. For more information visit tropiclear.com

tropiclear.com

POOL WATER TROUBLESHOOTING GUIDE

PROBLEM	CAUSE	TREATMENT	PREVENTIVE MAINTENANCE
Black and/or dark green spots on the wall	Black algae due to low sanitizers in water	Use Black Algae Destroyer per directions. Brush spots daily until gone.	Maintain a Free Available Chlorine residual of 1-3 ppm using TropiClear® Sanitizing Chemicals .
Yellow/Orange spots on walls, etc	Mustard algae	Use Algaecide 60 and check pH.	Maintain pH (7.2-7.6) range. Treat weekly with Super Shock .
	Iron in water	Use Metal Out to remove iron stains.	Add Metal Out periodically.
	Slimy yellow deposits	Use Yellow Eliminator .	Add No More Troubles® at a weekly rate.
Cloudy green water	Green algae	Use Algaecide 60 .	Add Algaecide 60 : 2 to 4 ounces per 10,000 gallons every 5-7 days after initial treatment.
	Copper or iron dissolved in water	Check pH, use Metal Out to remove iron stains.	Add Metal Out , make sure pH is balanced before adding.
Brown/Reddish water, brown stains or rust	Corrosion of metal pool hardware due to low pH	Adjust pH to 7.2 to 7.6 by adding pH Plus . Use Metal Out .	Add Alkalinity Control weekly to prevent pH swings.
	Iron or manganese	Adjust with Metal Out .	Treat with Metal Out periodically.
	High pH & Total Alkalinity	Lower to proper range with pH Minus .	Test daily, add Alkalinity Control to prevent pH swings.
Clear green water	Corrosion of copper/metal pipes and pool equipment	Adjust pH to 7.2 to 7.6 by adding pH Plus .	Add Alkalinity Control weekly to prevent pH swings.
	Dissolved copper or iron from fill water	Treat with Metal Out .	Treat with Metal Out periodically.
	Very high pH and Total Alkalinity	Correct with pH Minus .	Test daily and adjust to maintain pH at 7.2-7.6 and Total Alkalinity at 75-120 ppm, add Alkalinity Control .
Cloudy Water	Filter not removing small particles	Treat with 4 in 1 Clarifier	Use weekly dosage of 4 in 1 Clarifier . Clean filter weekly.
	Free Chlorine residual too low	Shock with Super Shock .	Maintain Free Chlorine level at 1-3 ppm at all times regardless of pool usage or weather conditions. Shock every other week with Super Shock .
	Inadequate filtration	Clean filter with TSP or Filter Cleaner .	Use 4 in 1 Clarifier to coagulate micro particles.
	Rainfall	Shock treat with Super Shock to destroy dirt and/or odors.	Shock every other week with Super Shock .
	High pH or Total Alkalinity	Use pH Minus .	Test pH daily, treat as needed, add Alkalinity Control .
Oil/Grime on tile and vinyl	Build-up of oils and lotions	Use Tile & Vinyl Brite to remove grime and restore luster.	Add Skum Remover weekly to prevent build up and improve filtration.
Calcium scale deposits	Hard water or high pH or Total Alkalinity	Use Metal Out and pH Minus .	Add Metal Out . Test daily and maintain pH (7.2-7.6) range.
Chlorine odor	Combined Chlorine level too high	Shock treat with Super Shock to destroy Combined Chlorine.	Maintain disinfectant residual of 1-3 ppm at all times. Routinely shock treat with Super Shock .
	pH too low or high	pH Plus or pH Minus .	Test daily, add Alkalinity Control .
Skin/Eye irritation	Formation of Combined Chlorine in pool water	Shock treat with Super Shock to destroy Combined Chlorine.	Treat with Super Shock . Treat weekly with Skum Remover .
Scum along water line	Body oils, grease and dirt accumulations	Use Skum Remover and Tile & Vinyl Brite .	Maintain clean filter with periodic cleaning using Filter Cleaner . Add Skum Remover weekly to keep pool water scum free.



Complete Line of Quality Pool Care
Making pools carefree

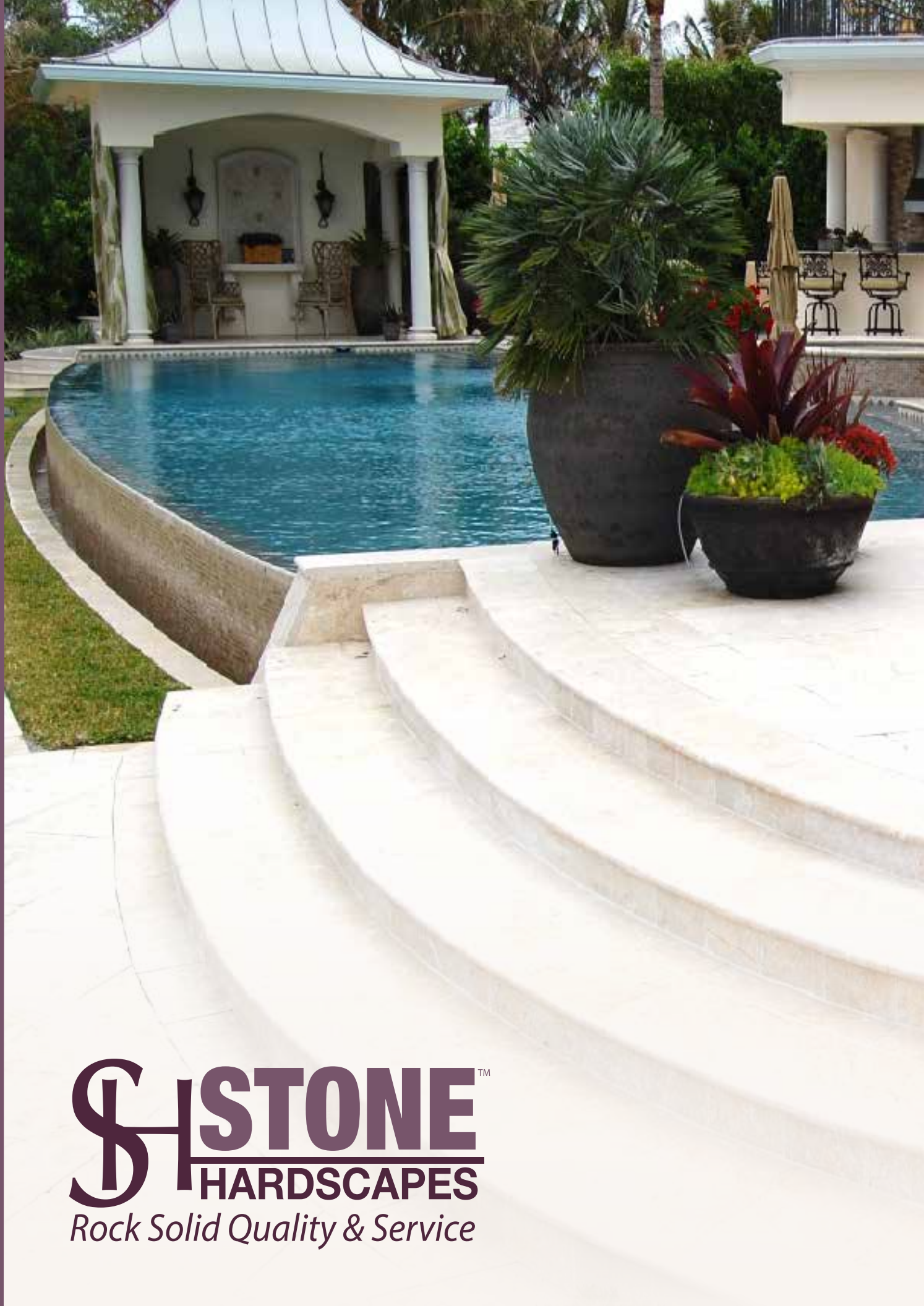

STONETM
HARDSCAPES
Rock Solid Quality & Service



StoneHardscapes is one of the leading manufacturers and distributors of the finest, hand-selected, natural stone in the world. Unlike other manufacturers, StoneHardscapes focuses solely on the production of stone selections ideal for exterior use. This focus allows us to cultivate selections, finishes and variations unique to the industry. Whether you are looking for high volume, price conscious, standard selections or custom options, StoneHardscapes is the perfect choice to serve all of your natural stone needs.

Safe

StoneHardscapes Natural Stone Pavers are skid-resistant and safe for exterior use.

Cool

StoneHardscapes Natural Stone Pavers remain cool to the touch, despite extensive sun exposure, creating the perfect exterior flooring.

Bright

StoneHardscapes Natural Stone Pavers are a product of nature, therefore they can endure prolonged sun exposure without fading.

Easy

StoneHardscapes Natural Stone Pavers are easy to maintain. Their low maintenance requirements reduce ongoing costs and add enduring curb appeal and increased property value.

A Collection of Natural Stone Pavers, Veneer & Accessories



Ledgestone • Honey Dew Pencil

Coping & Pavers • Ivory/Natural



Pavers • Crema Bella

Patio Pavers • Driveway Pavers • Pool Coping • Deck Drains •
Ledgestone Veneer • Splitface Veneer • Mosaic Tiles

For design inspiration or to view our complete catalog of selections visit StoneHardscapes.com



Pavers • Corsica Pearl



Ledgestone • Glacier

Pavers • Silver



Pavers • Walnut/Mocha





Top Mounted Valve Sand Filter

FEATURES

- Designed and manufactured with the highest quality of fiberglass and polyester resin with bobbin wound technology
- Available in sizes from 18" to 55" for inground pools
- Filter air release valve enables easy release of trapped air while the filter is operating
- Multi-port valve allows you to select from multiple flow and filter operational settings, with a simple-to-use lever dial
- Easy-to-use water drain plug
- Corrosion and UV resistant surface finish - suitable for all weather conditions

**Caution - Filters are not to be used when there is negative pressure*



SPECIFICATIONS

Model	TM450-18	TM550-21	TM650-25	TM700-28	TM760-30	TM860-32	TM960-36	TM1100-44	TM1200-48	TM1400-55
Filter Area (m ²)	0.15	0.22	0.32	0.37	0.44	0.58	0.70	0.93	1.10	1.50
Pipe Size (mm)	38	38	38	38	51	51	51	51	51	51
Design Flow Rate (m ³ /h)	7.5	11	15	18	22	24	31	40	46	52
Maximum Working Pressure PSI (bar)	36 (2.5) or 58 (4.0)	36 (2.5) or 58 (4.0)	36 (2.5) or 58 (4.0)	36 (2.5) or 58 (4.0)	36 (2.5) or 58 (4.0)	36 (2.5) or 58 (4.0)	36 (2.5) or 58 (4.0)	36 (2.5) or 58 (4.0)	36 (2.5) or 58 (4.0)	36 (2.5) or 58 (4.0)
Media Required (kg)	80	150	220	240	270	400	470	900	1300	1800

Filters with 4.0 bar maximum working pressure available on request

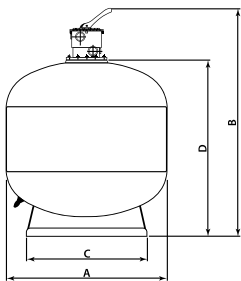

Model	TM450-18	TM550-21	TM650-25	TM700-28	TM760-30	TM860-32	TM960-36	TM1100-44	TM1200-48	TM1400-55
A (mm)	450	550	650	700	760	860	960	1100	1200	1400
B (mm)	780	840	1040	990	1090	1210	1280	1500	1580	1890
C (mm)	330	400	440	560	560	650	700	800	870	1050
D (mm)	530	600	680	750	800	920	990	1210	1290	1610



Side Mounted Valve Sand Filter

FEATURES

- Designed and manufactured with the highest quality of fiberglass and polyester resin with bobbin wound technology
- Available in sizes from 18" to 55" for inground pools
- Filter air release valve enables easy release of trapped air while the filter is operating
- Multi-port valve allows you to select from multiple flow and filter operational settings, with a simple-to-use lever dial
- Easy-to-use water drain plug
- Corrosion and UV resistant surface finish - suitable for all weather conditions



**Caution - Filters are not to be used when there is negative pressure*

SPECIFICATIONS

Model	SM450-18	SM550-21	SM650-25	SM700-28	SM760-30	SM860-32	SM960-36	SM1100-44	SM1200-48
Filter Area (m ²)	0.15	0.22	0.32	0.37	0.44	0.58	0.70	0.93	1.10
Pipe Size (mm)	38				51				
Design Flow Rate (m ³ /h)	7.5	11	15	18	22	24	31	40	46
Maximum Working Pressure PSI (bar)	36 (2.5) or 58 (4.0)	36 (2.5) or 58 (4.0)	36 (2.5) or 58 (4.0)	36 (2.5) or 58 (4.0)	36 (2.5) or 58 (4.0)	36 (2.5) or 58 (4.0)	36 (2.5) or 58 (4.0)	36 (2.5) or 58 (4.0)	36 (2.5) or 58 (4.0)
Media Required (kg)	80	150	220	240	270	400	470	900	1300

Filters with 4.0 bar maximum working pressure available on request

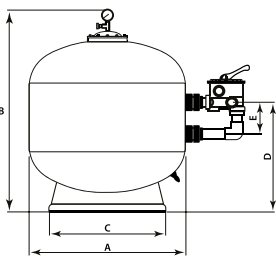

Model	SM450-18	SM550-21	SM650-25	SM700-28	SM760-30	SM860-32	SM960-36	SM1100-44	SM1200-48
A (mm)	450	550	650	700	760	860	960	1100	1200
B (mm)	705	770	850	920	970	1090	1160	1380	1480
C (mm)	330	400	440	560	560	650	700	800	870
D (mm)	360	410	450	500	540	590	640	810	900
E (mm)	120	140	140	160	180	180	190	240	240



Commercial Filter

FEATURES

- Designed and manufactured with the highest quality of fiberglass and polyester resin with bobbin wound technology
- Available in sizes from 48" - 98" for inground pools
- Filter air release valve enables easy release of trapped air while the filter is operating
- Multi-port valve allows you to select from multiple flow and filter operational settings, with a simple-to-use lever dial
- Easy-to-use sand and water drain plug
- Large top manhole makes it easy to access the filter interior
- Corrosion and UV resistant surface finish - suitable for all weather conditions



**Caution - Filters are not to be used when there is negative pressure*

SPECIFICATIONS

Model	FSM 1200- 48"	FSM 1400- 55"	FSM 1600- 63"	FSM 1800- 70"	FSM 2000- 78"	FSM 2300- 90"	FSM 2500- 98"
Filter Area (m ²)	1.10	1.52	1.98	2.50	3.11	4.11	4.90
Pipe Size (mm)	80	100	100	150	150	200	200
Design Flow Rate (m ³ /h)	33/44	46/60	60/80	75/101	94/125	124/164	148/197
Maximum Working Pressure PSI (bar)	36 (2.5) or 58 (4.0)	36 (2.5) or 58 (4.0)	36 (2.5) or 58 (4.0)	36 (2.5) or 58 (4.0)	36 (2.5) or 58 (4.0)	36 (2.5) or 58 (4.0)	36 (2.5) or 58 (4.0)
Media Required (kg)	1100 & 300	1400 & 450	2400 & 800	3000 & 1000	4500 & 1500	6000 & 2000	8500 & 3000

*Flow rate is calculated at a specific velocity of 30 m³/hr/m² and 40 m³/hr/m²
Filters with 4.0 bar maximum working pressure available on request*

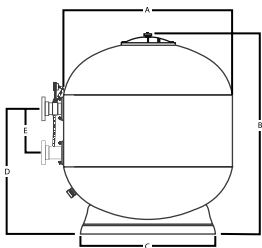

Model	FSM 1200- 48"	FSM 1400- 55"	FSM 1600- 63"	FSM 1800- 70"	FSM 2000- 78"	FSM 2300- 90"	FSM 2500- 98"
A (mm)	1200	1400	1600	1800	2000	2300	2500
B (mm)	1460	1700	1950	2150	2400	2700	2950
C (mm)	900	1020	1270	1430	1600	1830	2000
D (mm)	900	1050	1230	1350	1530	1700	1900
E (mm)	350	350	425	500	500	650	650



Cartridge Filters

AquatiX Cartridge Filters are designed to deliver superior filter cleaning performance. These low flow filters are built for all types of applications and weather conditions, are easy to install and require no backwashing with minimum maintenance needed to operate.

FEATURES

- Models available for pools up to 11.1 m³
- Top cover with locking feature for increased safety
- Pressure gauge and air release valve located on the filter cover for easy access
- Filter body constructed of the highest quality grade ABS materials for superior strength and durability
- Extra-large cartridge element engineered to provide maximum flow performance and efficiency
- Optional PVC unions available for easy installation and servicing



SPECIFICATIONS

Model	C1025	C1036	C1050	C1070	C1100	C1120
Filter Area (m ²)	2.32	3.34	4.64	6.5	9.28	11.1
Pipe Size (mm)	38					
Design Flow Rate (m ³ /h)	25 (5.6)	35 (7.9)	50 (11.3)	70 (15.8)	90 (20.4)	110 (24.9)
Maximum Working Pressure PSI (bar)	50 (3.5)	50 (3.5)	50 (3.5)	50 (3.5)	50 (3.5)	50 (3.5)
Weight (kg)	4.5	5.3	6.2	7.4	7.5	8
Dimensions (cm)	28 x 28 x 51	28 x 28 x 62	28 x 28 x 76	28 x 28 x 90	28 x 28 x 109	28 x 28 x 119

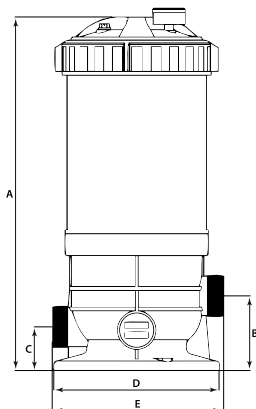

Model	C1025	C1036	C1050	C1070	C1100	C1120
A (mm)	460	570	708	809	999	1099
B (mm)	120	120	120	120	120	120
C (mm)	70	70	70	70	70	70
D (mm)	266	266	266	266	266	266
E (mm)	276	276	276	276	276	276



Sand Filter Combo System

AquatiX Sand Filter Combo units are designed to deliver a combination of energy efficiency and superior filter cleaning performance for outstanding water clarity. These filters are suitable for all types of applications and weather conditions.

FEATURES

- Available in sizes from 16" - 24"
- High performing filtration and pump combo system provides optimal performance
- Energy efficient pump
- Filter body engineered from the highest grade of materials for superior strength and durability
- Easy installation
- Low maintenance needed to operate
- 7-position valve allows you to select from multiple flow and filter operational settings, with a simple-to-use lever dial



SPECIFICATIONS

Model	Description	Voltage / Hertz	Weight (kg)	Dimensions (cm)
F116T1607	16" Sand Filter with 0.75HP P1607 pump (CSA)	220-240/50	20.5	64 x 64 x 62
F119T1610	19" Sand Filter with 1HP P1610 pump (CSA)	220-240/50	24.4	65 x 71 x 73
F124T1615	24" Sand Filter with 1.5HP P1615 pump (CSA)	220-240/50	32.4	65 x 83 x 88
F119T1707	19" Sand Filter with 0.75HP P1707 pump (CSA)	220-240/50	21.5	74 x 64 x 70
F124T1710	24" Sand Filter with 1HP P1710 pump (CSA)	220-240/50	25.2	84 x 64 x 88

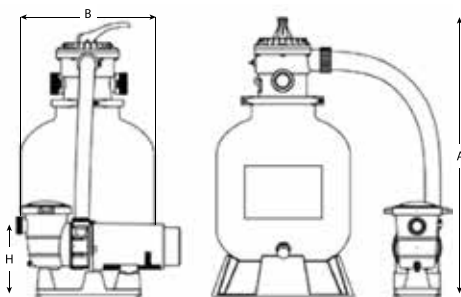

Model	F116T1607	F119T1610	F124T1615	F119T1707	F124T1710
A (mm)	810	929	1110	929	1110
B (mm)	406	482	609	482	609
H (mm)	355			381	



Cartridge Filter Combo System

AquatiX Cartridge Filter Combo units are designed to deliver a combination of energy efficiency and superior filter cleaning performance for outstanding water clarity.

FEATURES

- Models available for pools up to 110 m³
- High performing filtration and pump combo system provides optimal performance
- Energy efficient pump
- Filter body engineered from the highest grade of materials for superior strength and durability
- Easy installation
- Low maintenance needed to operate



SPECIFICATIONS

Model	Description	Pool Size (m ³)	Voltage/Hertz	Weight (kg)	Dimensions (cm)
F10257205	C1025 (2.32 m ²) Filter with 550W P7205 pump	40 - 45	230/50	15	62 x 60.5 x 30.5
F10367205	C1036 (3.34 m ²) Filter with 550W P7205 pump	45 - 44	230/50	15.9	62 x 57 x 30.5
F10507205	C1050 (4.64 m ²) Filter with 550W P7205 pump	65 - 88	230/50	16.8	76 x 59 x 30.5
F10707207	C1070 (6.5 m ²) Filter with 550W P7207 pump	90 - 110	230/50	19.1	90 x 61 x 30.5

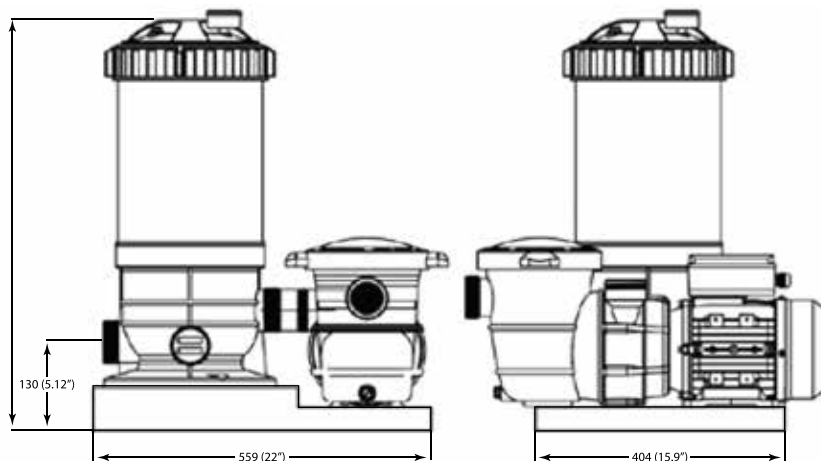



SF Series Self Priming Pump

FEATURES

- Self-priming - suction lift up to 1.8 m above the water level
- Pump components are made of superior strength corrosion resistant material for increased life and durability
- See-through lid provides easy visibility and access
- High flow impeller is made of heavy duty engineered grade plastic to withstand all weather conditions
- Mechanical seals are designed for long life and quiet operation
- High performance motor is equipped with thermal protection to prevent overheating, increase safety and reliability
- Waterproof grade: IPX5, 100% drip proof
- All electrical insulation for motor wires are Class F grade for safety



SPECIFICATIONS

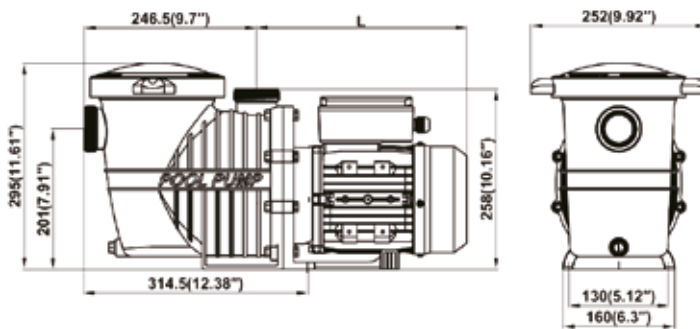

Model	P6007	P6010	P6015
Input Power (watts)	800	1000	1400
Electrical Voltage	220-240V/50Hz/1Ph		
Amps	3.5	4.5	6.4
Port Size (in mm)	1.5 38		
Qmax (L/min)	250	300	360
Weight (kg)	4.8	5.7	6.5
Dimensions (mm)	246.5 x 252 x 295		

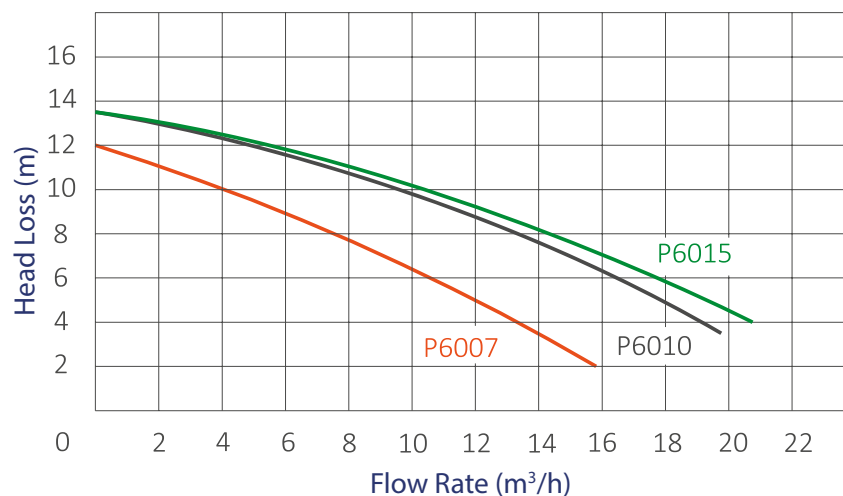



SF Pro Series Self Priming Pump

FEATURES

- Self-priming - suction lift up to 2.5 m above the water level
- Pump is designed with high flow rate for faster turn over
- High flow impeller is made of heavy duty engineered grade plastic to withstand all weather conditions
- Mechanical seals are designed for long life and quiet operation
- High performance motor is equipped with thermal protection to prevent overheating, increase safety and reliability
- Waterproof grade: IPX5, 100% drip proof
- All electrical insulation for motor wires are Class F grade for safety



SPECIFICATIONS

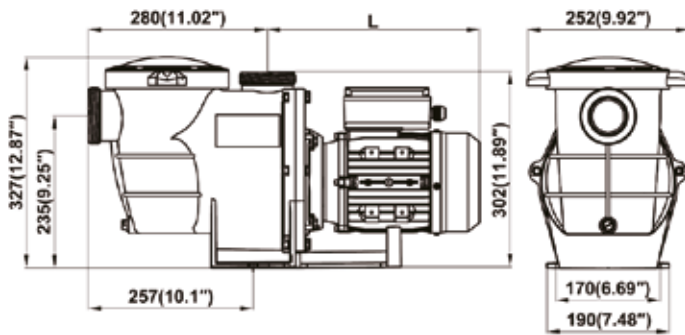

Model	P6115
Input Power (watts)	1500
Electrical Voltage	22-240V/50Hz/1Ph
Amps	6.4
Port Size (in mm)	2 50.8
Qmax (L/min)	380
Weight (kg)	15.1
Dimensions (mm)	280 x 252 x 327

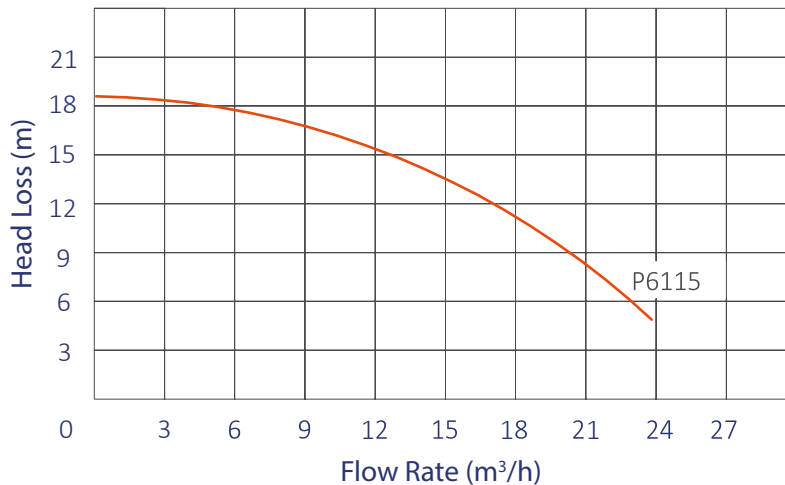



SPL Series Pump

FEATURES

- High flow pump provides superior filtering cycles and water circulation
- High performance 3-phase motor is equipped with thermal protection to prevent overheating, increase safety and reliability
- High head capacity
- Pump components are made of superior strength corrosion resistant material for increased life and durability
- Mechanical seals are designed for long life and quiet operation
- Convenient handle provides easy access to strainer basket
- Easy to operate and service



SPECIFICATIONS

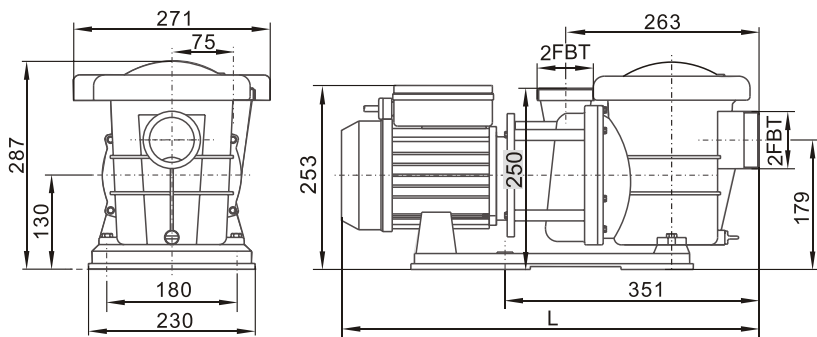

Model	SPL030
Input Power (watts)	2200
Electrical Voltage	220V/50Hz/3Ph
Amps	10
Port Size (in mm)	2.5 63.5
Pool Water Flow (L/min)	600
Weight (kg)	18
Dimensions (mm)	625 x 295 x 345

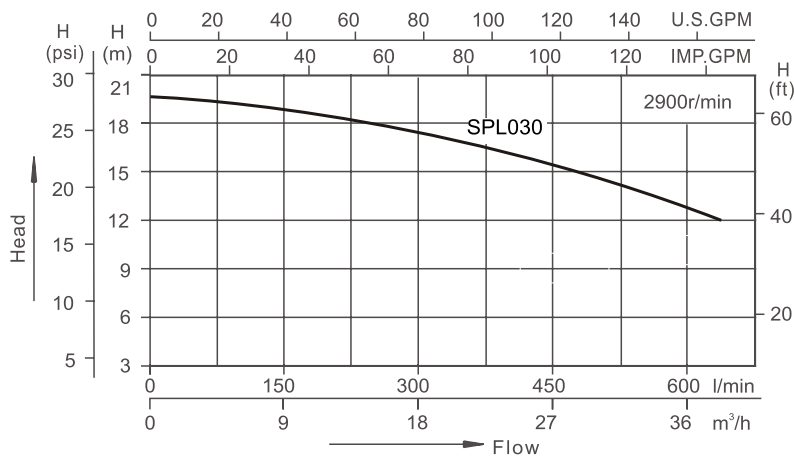



SPK Series Pool Pump

FEATURES

- High flow pump provides superior filtering cycles and water circulation
- High performance motor is equipped with thermal protection to prevent overheating, increase safety and reliability
- Pump components are made of superior strength corrosion resistant material for increased life and durability
- Mechanical seals are designed for long life and quiet operation
- Convenient handle provides easy access to strainer basket
- Easy to operate and service



SPECIFICATIONS

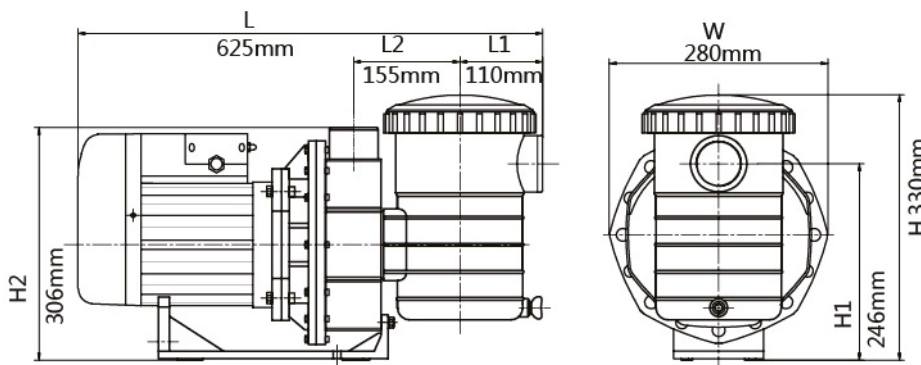

Model	SPK-030
Input Power (watts)	2200
Electrical Voltage	380V/50Hz/3Ph
Amps	5.79
Port Size (in mm)	2 50.8
Pool Water Flow (L/min)	360
Weight (kg)	25
Dimensions (mm)	625 x 280 x 330

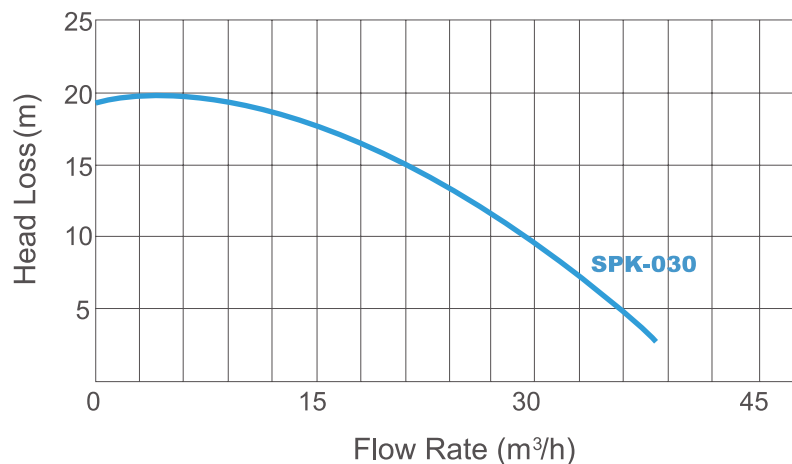



SPK Series Commercial Pool Pump

FEATURES

- High flow pump provides superior filtering cycles and water circulation
- High performance 3-phase motor is equipped with thermal protection to prevent overheating, increase safety and reliability
- High head capacity
- Pump components are made of superior strength corrosion resistant material for increased life and durability
- Mechanical seals are designed for long life and quiet operation
- Convenient handle provides easy access to strainer basket
- Easy to operate and service



SPECIFICATIONS

Model	SPK-040	SPK-055	SPK-075	SPK-100	SPK-150
Input Power kW (HP)	3.0 (4.0)	4.0 (5.5)	5.5 (7.5)	7.5 (10)	11 (15)
Electrical Voltage	380V/50Hz/3Ph			380V/50Hz/3Ph	
Port Size (in mm)	3 76.2				
Hmax (m)	22	19	20	21	22
Qmax (m ³ /h)	45	60	80	95	110

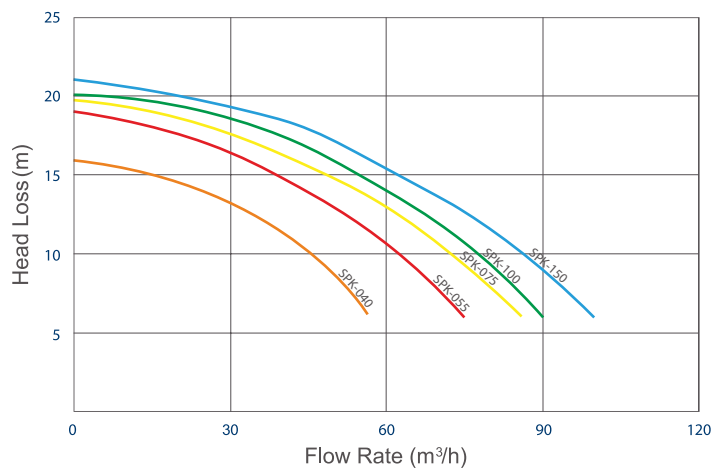
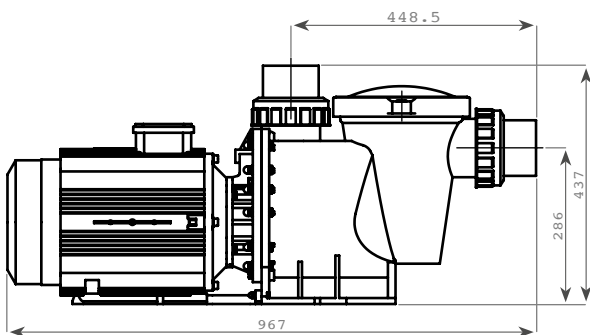



SFN Series High Performance Pumps

FEATURES

- Models designed for commercial pools and water feature applications
- High flow pump provides superior filtering cycles and water circulation
- High performance motor is equipped with thermal protection to prevent overheating, increase safety and reliability
- Pump components are made of superior strength corrosion resistant material for increased life and durability
- Mechanical seals are designed for long life and quiet operation
- Convenient handle provides easy access to strainer basket
- Easy to operate and service



SPECIFICATIONS

Model	SFN020	SFN030	SFN040	SFN050	SFN055	SFN075
Input Power kW (HP)	1.5 (2.0)	2.2 (3.0)	3.0 (4.0)	3.8 (5.0)	4.0 (5.5)	5.5 (7.5)
Electrical Voltage	220V/380V/50Hz/3Ph			380V/50Hz/3Ph		
Port Size (in mm)	2 63		2/2.5 63/75		2.5 75	
Hmax (m)	18	20	20	21	22	22
Qmax (m ³ /h)	35	38	45	50	60	75
Motor Speed (r/min)	2800					
Dimensions (mm)	650/720 x 330 x 295					
Inlet Center Height (mm)	225					
Inlet & Outlet Center Distance (mm)	285					

- SFN020
- SFN030
- SFN040
- SFN050
- SFN055
- SFN075

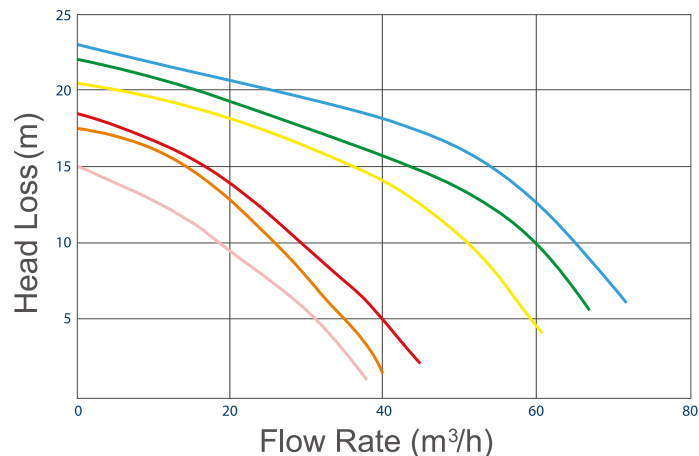



UV Purification System

UV Systems can work in conjunction with Chlorine or Salt Chlorination Systems to provide a secondary sanitizer to reduce Chlorine usage by up to 80%.

FEATURES

- Improves water quality, breaking down chloramines and other chlorine resistant organics
- Green technology – dramatically reduces chemical demand, to provide crystal clear water with no skin irritation or red eyes
- Germicidal UV bulbs offer an extended 9,000 hours of sanitation time
- Models designed for residential and commercial applications
- Can treat swimming pool water up to 150 m³ with high flow rates up to 34,450 L/hr
- Easy to install and service when needed



SPECIFICATIONS

UV Model	15 Watt	25 Watt	30 Watt	55 Watt	75 Watt	110 Watt	220 Watt
Pool Size (m ³)	15	25	30	55	75	110	150
Flow Rate (m ³)	7.5	10	15	20	25	25	25
Connections (in mm)	1.5 50	1.5 50	1.5 50	1.5 50	1.5 50	2 63	2 63

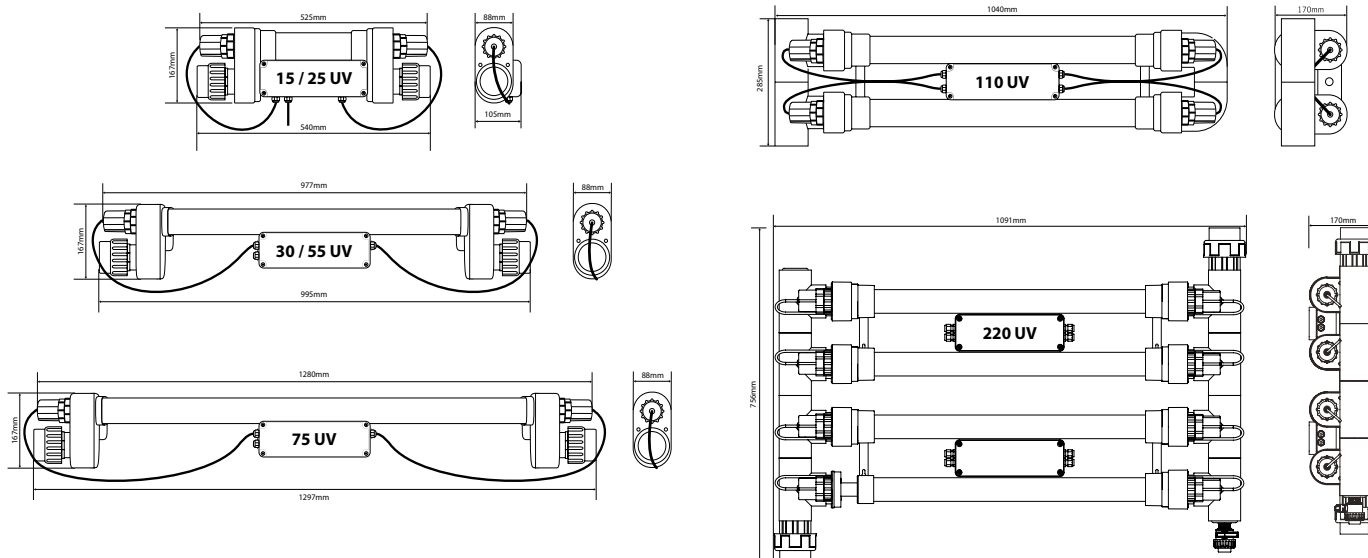

AquatiX Pool Products



Maintenance

Brushes - with Aluminum backs



10" Pool Algae Brush

Item Number	B7511
Type	Stainless Steel Bristles
Weight (kg)	3.7 / 3.4
Dimensions (cm)	31 x 21 x 32



18" Pool Algae Brush

Item Number	B7535
Type	Stainless Steel Bristles
Weight (kg)	5.4 / 4.8
Dimensions (cm)	49 x 22 x 31



18" Pool Wall Brush

Item Number	B7533CB
Type	Nylon Bristles
Weight (kg)	5.4 / 4.8
Dimensions (cm)	49 x 22 x 31

Leaf Skimmers - with Aluminum backs



Deluxe Pro-Series Deep Leaf Skimmer

Item Number	B7615CB
Weight (kg)	8.7 / 7.6
Dimensions (cm)	44 x 41 x 53



Deluxe Pro-Series Leaf Skimmer

Item Number	B7604
Weight (kg)	6.7 / 5.8
Dimensions (cm)	55 x 39 x 40

Vacuum Head and Hoses



13.78" Aluminum Vacuum Head with Spring Clip

Item Number	B7716CS
Weight (kg)	4.5
Dimensions (cm)	31 x 21 x 32



38 mm Blow Molded Hose

Item Number	Length (m)
B9120-9	9
B9120-15	15
<input checked="" type="checkbox"/> B9120-30	30

Poles



Telescopic Pole (Ridged)

Item Number	B8627
Description	2.4 m to 4.8 m
Color	Inner Pole: Blue Outer Pole: Blue



Three-Way Telescopic Pole (Ridged)

Item Number	B8633
Description	2.4 m to 7.2 m
Color	Inner Pole: Silver Outer Pole: Blue



White Goods



Multi Flow Wall Inlet

Item Number	B8592
Pipe Size	58 mm
Weight (kg)	0.15 / 0.18
Dimensions (cm)	52.5 x 32.5 x 32



Vacuum Point

Item Number	B8480
Pipe Size	58 mm
Weight (kg)	0.11 / 0.16
Dimensions (cm)	52.5 x 32.5 x 33



Bottom Inlet

Item Number	B8593
Pipe Size	50 mm
Weight (kg)	0.45 / 0.49
Dimensions (cm)	60.5 x 44.5 x 36



Standard Skimmer (For Concrete Pools)

Item Number	B8414
Pipe Size	58 mm
Weight (kg)	0.15 / 0.18
Dimensions (cm)	52.5 x 32.5 x 32



Wide Mount Skimmer (For Vinyl/Liner Pools)

Item Number	B8416
Pipe Size	58 mm
Weights (kg)	0.11 / 0.16
Dimensions (cm)	52.5 x 32.5 x 33



Circular Main Drain (For Concrete Pools)

Item Number	B8595
Pipe Size	63 mm
Weight (kg)	0.85 / 1.05
Dimensions (cm)	45.5 x 45.5 x 37



Main Drain (For Vinyl Pools)

Item Number	B8596
Pipe Size	63 mm
Weight (kg)	0.91 / 1.15
Dimensions (cm)	45.5 x 45.5 x 38



Junction Box in ABS

Item Number	B8574
Pipe Size	50 mm
Weight (kg)	2.64 / 3.95
Dimensions (cm)	30.5 x 30.5 x 36



Standard Jet & Body

Item Number	B8483
Pipe Size	25 mm air / 40 mm Tee body
Weight (kg)	17.5 / 19
Dimensions (cm)	51.5 x 34 x 45



Standard Jet

Item Number	B8484
Pipe Size	25 mm air / 40 mm Tee body
Weight (kg)	17.5 / 19
Dimensions (cm)	51.5 x 34 x 45



Air Jet / Air Blower Nozzle

Item Number	B8482
Pipe Size	89 mm
Weight (kg)	5 kg / 6 kg
Dimensions (cm)	44.5 x 34 x 37

Underwater Swimming Pool Lights

Blue Underwater Pool LED Light – Stainless Steel

High quality performance

FEATURES

- Available in warm/cool white and blue color options
- Models available in 10, 16 and 32 watts
- Includes 1.75 m cable
- Easy installation designed for existing pools and new pool construction
- IP68 rating performance
- Installs easily into standard 12-volt DC driver
- Driver required (not included)
- 1 year warranty



ITEM #
AQ-10W-SS
AQ-16W-SS
AQ-32W-SS

ABS Underwater Pool LED Light

FEATURES

- Available in warm/cool white and blue color options
- Models available in 10, 16 and 32 watts
- Includes 1.75 m cable
- Easy installation designed for existing pools and new pool construction
- IP68 rating performance
- Installs easily into standard 12-volt DC driver
- Driver required (not included)
- 1 year warranty



ITEM #
AQ-10W-ABS
AQ-16W-ABS
AQ-32W-ABS

SPECIFICATIONS

Packing/Box Dimensions	240 mm x 235 mm x 70 mm
Light Dimensions	230 mm x 58 mm





COMMERCIAL FILTERS



Micron Horizontal
Commercial Filter



Micron Side Mount
Fiberglass Filter



Micron Side Mount
Deep Bed Filter



Micron Top Mount
Fiberglass Filter

COMMERCIAL POOL PUMPS



Hydrostar
Commercial



Hydrostar Plus
Commercial

BIOFILTRATION FILTERS



Aquabiome
Filtration System

ROBOTIC POOL CLEANERS



Waterco Trident
PLUS



Waterco Trident
ECO



Waterco Trident
PRO

FILTRATION SYSTEMS



Trimline Cartridge



Micron Media Filters



Opal Cartridge



MultiCyclone 12 Centrifugal Filter

POOL PUMPS



Supastream Pool Pump



Supatuf Pool Pump

LED POOL LIGHTING



Britestream Fiberglass SLIM165



Britestream Fiberglass SLIM90



Britestream Surface Mounted LED



Britestream Concrete NICHE165

WELCOME TO THE MODERN POOL



WELCOME TO CLEANER, CLEARER, SAFER WATER

ADVANCED SANITIZERS FOR THE MODERN POOL

DEL Advanced Sanitizer Solutions is now a part of the CMP family and we couldn't be more excited. Paired with an effective residual sanitizer, DEL products create the safest possible pool by destroying 99.99% of dangerous contaminants. DEL is a pioneer of patented Ozone and AOP technologies. As a part of CMP, DEL is now an integral piece of building a complete modern safe pool.

FIND OUT WHAT'S NEW AT C-M-P.COM/DEL

Prozone Water Products

Natural Pool Water Treatment

PZ2 Series Commercial Systems (PZ2-4 - PZ2-48) Skid Mount Systems

The PZ2 Series for pools up to 600,000 gallons are compressor driven ozone systems which can inject ozone under almost any hydraulic condition including pools with in-floor cleaners. The systems are built with commercial grade compressors, solid state power supplies, our advanced hybrid ozone generator and muffling to ensure quiet operation.



PZ2-4
Inside



PZ2-12 Skid Mount
Ozone Side

*Reduces Chemical Usage, Improves Sanitation
Eliminates Odors, Produces Crystal Clear Water*

Applications Include:

Commercial Pools
Commercial Spas
Water Features
Spray Pads
Water Parks
Aquariums
Aquaculture

Benefits:

- Save up to 80% on Costly Chemical
- Low Cost, Low Maintenance Operation
- Produces Fresh, Crystal Clean Water
- Improves Sanitation
- Reduces Harsh Chemicals
- Eliminates Eye, Skin & Hair Irritation
- Saves Maintenance, Time and Money
- Eliminates Chemical Odors
- Prolongs Equipment Life

Easy Turn-key water in - water out installation. Larger skid systems may be split to fit through doors and can mount on a wall.

O₃ NATURAL TECHNOLOGY

No recurring maintenance or special skills are required. All PZ2 residential and commercial systems carry a two-year warranty; the compressor carries a one-year warranty. Contact a Prozone engineer for further engineering details on the PZ2 Series.

Electrical System Options

- 110/220 VAC, 60hz
- 220/240 VAC, 60hz
- 230 VAC, 50hz
- Universal Solid State Inverter Ballast:
90 VAC to 270 VAC

Specifications

- Ozone Output (Nominal): 2 - 24 grams/hour
- Arc Life (Nominal): 20,000 Hours
- Compressor Life (Nominal): 40,000 Hours
- Operating Temperature: -25°F to +125°F
- Storage Temperature: -60°F to +140°F



PZ2-12 Skid Mount
Counter Flow Side

Skid Mount Systems Include

- Extruded Aluminum Frame
- 2" Counter Flow Contacting
- 4" Degas Column
- Venturi Ozone Injection
- Circulation Pump

Additional Upgrade Options

- ORP and pH Monitoring
- Ozone Destruct
- Ozone Monitoring
- Below Water Solenoid Kit



Patents, International Patents & Patents Pending Copyright 2017

Prozone Water Products

Natural Pool Water Treatment

Commercial Hybrid Systems

The Commercial Hybrid Systems are designed for all recreational water & Commercial pools, Prozone delivers superior water quality.

PZ2 Series

PZ2 units provide superior ozone generation by pressurising the lamp cartridges and superior ozone mass transfer into water from the turbulence created by the compressed air stream. PZ2 units require no operator interface once they are set-up. No recurring maintenance or special skills are required. The PZ2 Series has a hardware warranty for a full one year on residential and commercial systems.

Custom Engineered For Each Application

The PZ2 Series ozone generators are custom engineered for each application. This allows for a fast and easy installation with a simple coupling connection to the plumbing. All units have pressurised cartridges combined with high airflow compressors to produce maximum ozone output. Systems may be combined to treat any swimmin pool systems up to 7,500,000 litres. They are designed for use in the most demanding environments and can withstand heavy impacts. Since the PZ2 Series systems have multiple redundant design, there is no down-time due to cartridge failure.



Specifications

Electrical	220/240 VAC / 60 Hz
Universal Solid State Inverter Ballast	110-290 VAC
Arc Life (Nominal)	20,000 hours
Compressor Life (Nominal)	40,000 hours
Storage Temperature	-15 °C - +70 °C
Operating Temperature	-4 °C - +60 °C



Degassing Column

The Prozone degassing column removes excess air after the water ozonated to prevent bubbles from entering the pool. The unit consists of a column with an air vent attached to the top. Excess air is removed by using the natural buoyancy of bubbles and a counter flow design that allows for the removal of 99% of injected air. A degassing column can be an optional extra for any PZ2 system.

Important: Prozone ozone generation systems must be used in conjunction with either chlorine or bromine. Ozone oxidises combined the chlorine and bromine freeing it to be continuously re-used. This reduces chemical consumption and eliminates eye and skin irritation.

Commercial Pool Sizing

	Chlorine	Bromine
PZ2-4	50,000 gal.	25,000 gal.
PZ2-8	100,000 gal.	50,000 gal.
PZ2-12	150,000 gal.	75,000 gal.
PZ2-16	200,000 gal.	100,000 gal.
PZ2-24	300,000 gal.	150,000 gal.
PZ2-36	400,000 gal.	200,000 gal.
PZ2-48	600,000 gal.	300,000 gal.

Nominal Ozone Output

	Grams Per Hour
PZ2-4	2 grams/hour
PZ2-8	4 grams/hour
PZ2-12	6 grams/hour
PZ2-16	8 grams/hour
PZ2-24	12 grams/hour
PZ2-36	18 grams/hour
PZ2-48	24 grams/hour



Patents, International Patents & Patents Pending Copyright 2017

Prozone Water Products

Natural Pool Water Treatment

PZ7 Series Residential Systems (PZ7-1 PZ7-2) In Ground Pools

The PZ7 Series generator features our unique patented Bypass Venturi configuration for quick installation on the return line of the pool. This allows maximum ozone/water mixing to purify the water before it reaches the pool. The heavy extruded aluminium adds to its durability with clear gasketing that glows when the system is on. The PZ7-1 is rated for up to 15,000 gallons (68 m³) residential in-ground pools; and the PZ7-2 for pools up to 40,000 gallons (152 m³)



Perfect for Pool & Spas

Prozone Water Purification Systems can easily be installed in new pools or retrofitted to existing pools. It attaches to the water circulation system quickly and easily, generating ozone and injecting it into the the return, where it instantly purifies the water. In the process, ozone biologically destroys bacteria, virus and algae and oxidises metals which bond together for easy removal by the filter.

Features

- Universal Power supply
- Prozone Patented Corona Hybrid Arc Tube harnesses the high ozone concentrations of Corona Discharge generators while maintaining the simplicity and reliability of VUV Hybrid
- Optional Prozone Patented Dynamic Venturi Injector Bypass System allows maximum ozone/water mixing for superior water quality. The bypass also means a quick retrofit installation or replacement for all existing ozone generators.
- Low cost, low maintenance operation
- 2 year warranty

T-O₃ NATURAL TECHNOLOGY

*Reduces Chemical Usage, Improves Sanitation
Eliminates Odors, Produces Crystal Clear Water*

What is Corona Hybrid Technology?

Prozone's patented Corona Hybrid Ozone systems combine VUV and Corona discharge technologies. Hybrid systems provide higher concentration ozone generation without the corrosive by-product of traditional corona discharge machines. The result is a new technology that produces reliable output while taking advantage of VUV inherent simplicity, ruggedness and pure ozone production.

Specifications

	PZ7-1	PZ7-2
Electrical	230 VAC / 0.4 amps 92 Watts	230 VAC / 0.8 amps 184 Watts
Arc Life (Nominal)	20,000 hours	
Compressor Life (Nominal)	20,000 hours	
Storage Temperature	-15 °C - +70 °C	
Operating Temperature	-4 °C - +60 °C	

Pool Sizing

	Chlorine	Bromine
PZ7-1	20,000 gal.	10,000 gal.
PZ7-2	40,000 gal.	20,000 gal.

Spa Sizing

	Chlorine	Bromine
PZ7-1	800 gal.	400 gal.
PZ7-2	1,600 gal.	800 gal.



Patents, International Patents & Patents Pending Copyright 2017

ENDLESS POOLS FASTLANE

SWIMMING MACHINE

Turn Any Pool Into An Endless Pool

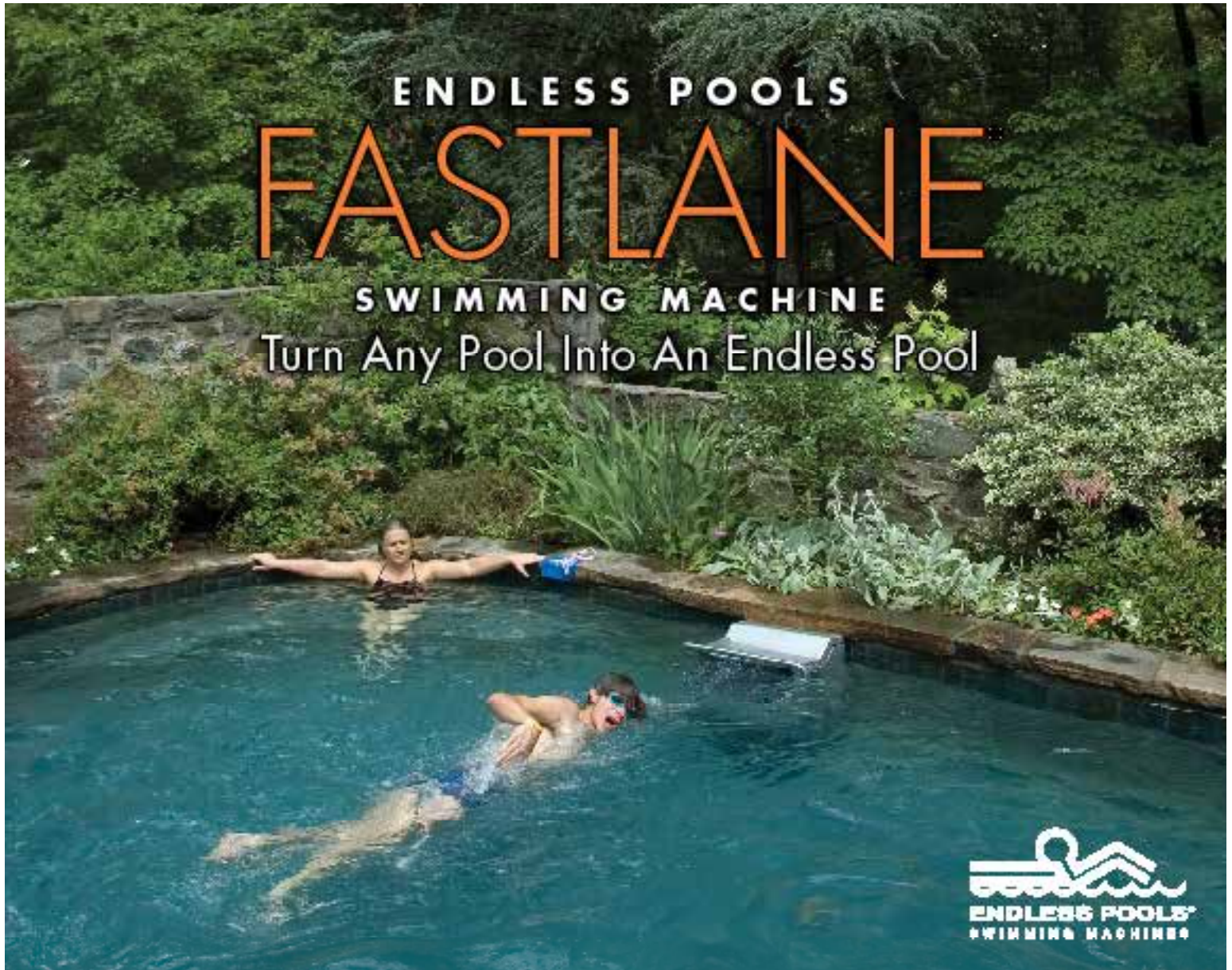

The Fastlane swimming machine produces a smooth, quiet, powerful current that's perfect for any backyard pool and it's adjustable from zero to 1:10/100 yards. Now you can turn any pool into an Endless Pool!

- Highest Quality Swim Current
- Fun for the Entire Family
- Simple to Use, Economical to Run
- Low Impact Exercise
- New Construction or Existing Pools
- Deck or Wall Mount Options

For fitness or fun, the Fastlane swimming machine adds a whole new dimension to your pool. The Fastlane system has two parts: a remotely located Hydraulic Power Unit that powers the swim current and the Swim Unit that mounts to the pool. The current is controlled by a remote control.

endlesspools.com

Fastlane® Specifications

- 35" water depth required
- VGB 2008 Compliant
- 5-HP swim current generator
- Acrylic and 316L stainless steel construction
- Available in platinum or sapphire
- 220-volt, 30-amp GFCI power required



Platinum



Sapphire

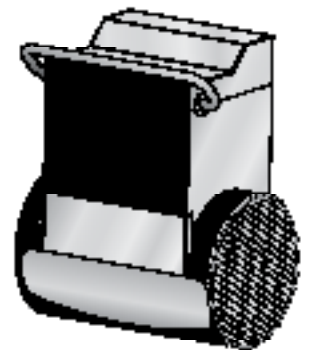



Hydrostride™ Underwater Treadmill

EXPERIENCE THE MOST REFRESHING TREADMILL IN YOUR TRADITIONAL POOL.

With the Endless Pools Hydrostride underwater treadmill, you can walk, jog, or run in your new backyard pool! Now an efficient workout can be as fun and easy as taking a dip in your pool, with no commute, no crowds, and no waiting.

Every day, thousands around the world walk and run on their Endless Pools treadmill. It's low-impact, so it's easier on knees and hips than jogging or running on dry land. It's a more effective workout due to water's 360-degree resistance, and thanks to its hydrostatic pressure, you can expect less muscle soreness after.



Endless Pools® Aquabike

THE NO-SWEAT WAY TO TAKE A SPIN.

Achieve the hard-earned results of a vigorous bike ride—without ever hitting the road. When you add our lightweight Aquabike into your Endless Pools model, you can experience a stationary cycling workout in water set to your ideal temperature. Stay cool as you burn calories and improve your cardiovascular health. Aquabike is packed with adjustable features that maximize your comfort and give you a perfect fit.

Beauty for all your senses



River Rok
Natural Pebble Pool Finish

DIAMOND BRITE
Exposed Aggregate Pool Finish

PURAZZO
Polished Marble Pool Finish

DIAMOND BRITE
Polished Marble Pool Finish

SGM exposed aggregate finishes are beautiful to the eyes and to the touch. Whether you prefer quartz finishes, natural pebble finishes or polished marble finishes, SGM is your best choice.

From surface preparation products, to tile & coping setting materials, SGM covers all your needs when it comes to the resurface of your pool or spa.

www.sgm.cc

SGM SWIMMING
POOL, SPA &
DECK FINISHES

taylor

the most trusted name in water testing

Engineered for Accuracy



- includes the parameters needed to keep water safe, clean and comfortable for swimmers
- FREE sureTREAT phone app
- as reliable as the liquid kits you have trusted for years

The Chemistry You Can Trust
 Designed for the kind of comprehensive, routine testing performed by:

- service technicians
- commercial public pool operators
- health department inspectors
- home owners



Go to www.taylor technologies.com to learn more.

Introducing The Space Age™ Solar Blanket

Patent 6,317,902

With Aluminum Heat Shield
 From the Originator

14.6% Greater Heat Retention
 Test conducted by a leading test laboratory

Electric Blue Heat Collector (top of Blanket)

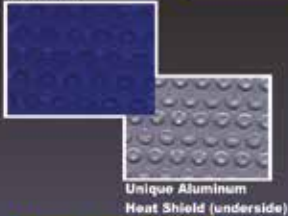

Here's How it works

The Space Age™ Solar Blanket collects heat from the sun's rays similar to a traditional blanket. Otherwise lost heat is reflected back into the pool from the special Aluminum underside.

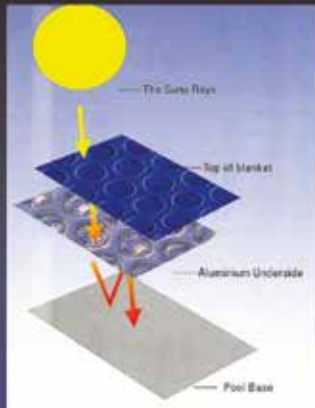

Featuring Blue Solar Blankets & Space Age™ Blankets



MIDWEST CANVAS CORP

Innovation meets **Relaxation**



Residential and Commercial **STEAMBATH SYSTEMS**



mr.steam® | Feel Good Inc.

www.mrsteam.com

STEAM. SAUNA. SOLUTIONS.



AX & AK Steam Generators



Commercial Boilers



Controls



Sauna Heaters

COMMERCIAL AND RESIDENTAL STEAM BATH & SAUNA PRODUCTS

In the steam and sauna business, the Amerec name is synonymous with quality and innovation. Amerec continually challenges industry

standards in sustainability and performance and succeeds in delivering products of the highest quality. *Discover the world of Amerec.*

amerec®

STEAM. SAUNA. SOLUTIONS.

www.amerec.com



Smart UV-C Solutions

PURIQ UV-C WATER PURIFIER

With the PURIQ UV-C water purifier you are guaranteed crystal clear water. Utilizing the latest technology, the lamp emits very powerful UV-C light with a wavelength of exactly 253.7 nm that kills practically all bacteria, viruses, algae and molds. This results in optimal purification, so the use of chlorine and other chemicals can be reduced by up to 80%! The PURIQ UV-C system, with its 100% eco-friendly operation, provides more natural, healthier water. Moreover, the extended life UV-C lamp lasts an incredible 12,000 hours.

The extra wide SAE 316 stainless steel housing extends the time the water is exposed to the strong UV-C radiation while also minimizing the pressure drop as the water passes through. Thanks to the polished interior, there is virtually no adhesion of contaminants to the walls, which boosts the effectiveness of the UV-C radiation by a further 35%. The PURIQ UV-C water purifier contains intelligent electronics that alert you when it is time to replace the lamp, which ensures that the unit is always operating at peak efficiency and your water is clear. This way, you always have a perfectly working device you can rely on!

Technical specifications	Bright 40	Bright 80	Bright 120
Maximum volume pool	40.000 L	80.000 L	120.000 L
Lamp wattage	41 watt	80 watt	125 watt
Lamp lifetime	12.000 h	12.000 h	12.000 h
UV-C Output	16 watt	27 watt	42 watt
Recommended flow	12.000 L/h	18.000 L/h	22.000 L/h
Maximum pressure	3 Bar	3 Bar	3 Bar
Connection supplied	63 mm	63 mm	63 mm
Length unit	950 mm	950 mm	950 mm
Diameter unit ø	89 mm	89 mm	89 mm

We recommend 1W per m3



PURIQ UV-C BENEFITS

- Reduces amount of chlorine/chemicals needed by up to 80%
- Kills molds, viruses, bacteria and algae
- High UV-C output from lamps based on the latest technology
- Extended life UV-C lamp: 12,000 hours
- Energy-efficient, 100% environmentally friendly operation
- Extra-large housing for longer exposure time
- 35% more UV-C output through reflection
- Very simple installation
- 3-year warranty against manufacturing defects





LOOP-LOC
THE WAY THE WAY

#ASKFORTHEELEPHANT



LOOP-LOC® COVERS

SAFETY POOL COVERS | 2020



MADE IN THE USA



SAFETY SWIMMING POOL COVERS

PROTECT YOUR FAMILY WITH THE ONLY MESH POOL COVER THAT PASSED THE ELEPHANT TEST:
“THE ELEPHANT™ COVER.”

LOOP-LOC® puts an unbreakable “lock” on your pool to protect your family. Only LOOP-LOC is available with the patented **CABLE-LOC™** and **GARGUARD®** Child Safety Intrusion Barriers. They close the dangerous gaps created where raised obstructions meet the cover’s edge, so there’s no way a child or pet can slip through.

LOOP-LOC’s exclusive Computer-Aided Design ensures a perfect, custom fit for any shape or size pool: from a simple square to the most complex installation, LOOP-LOC can manufacture a custom cover with the perfect fit for any pool or spa.

LOOP-LOC always stays tight, clean and beautiful on your pool – unlike a saggy, unsightly waterbag cover that becomes a dangerous, slippery swamp after just a few rains, LOOP-LOC’s super dense mesh allows rain to drain through. The cover stays dry and beautiful in any weather!

By following LOOP-LOC’s simple care and maintenance instructions for your mesh or solid cover, you’ll be able to open your pool with minimal cleaning and keep your cover in the best shape, year after year!

Unlike solid waterbag covers, a **LOOP-LOC requires no pumping, scrubbing or heavy maintenance**. Plus, it’s easy to install and remove with LOOP-LOC’s unique anchoring system.



#AskForTheElephant

(Please note: “Bubbles” the elephant is seen standing on the mesh cover as a demonstration of the substantial amount of weight that LOOP-LOC covers can withstand in the event of an emergency. Contact with sharp-hooved animals will damage the covers.)



Meets Safety Cover
In accordance with ASTM
Standard F 1346-91



UNIQUE ANCHORS

Offer ultimate protection and fit flush with the deck.

“THE ELEPHANT™ COVER”

SUPER DENSE MESH AVAILABLE IN GREEN OR DESIGNER
BLACK, GRAY, TAN OR BLUE TO COMPLEMENT YOUR OUTDOOR DÉCOR.

Preview any LOOP-LOC® Safety Cover with our Mirage Pool Visualizer at LoopLoc.com/Mirage.

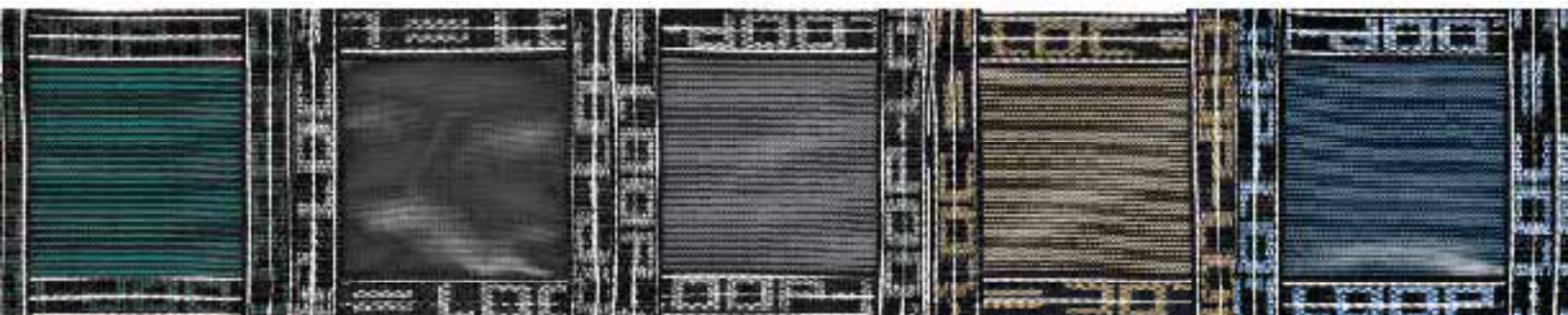

LOOP-LOC® covers not only meet, but exceed, ASTM standards for Safety Swimming Pool Covers F 1346-91. To show our commitment and dedication to the safety and security of your family, LOOP-LOC covers have undergone extensive outside testing through Underwriters Laboratories (UL) and have earned the seal of approval for safety swimming pool covers.



Blue Super Dense Mesh



Black Super Dense Mesh

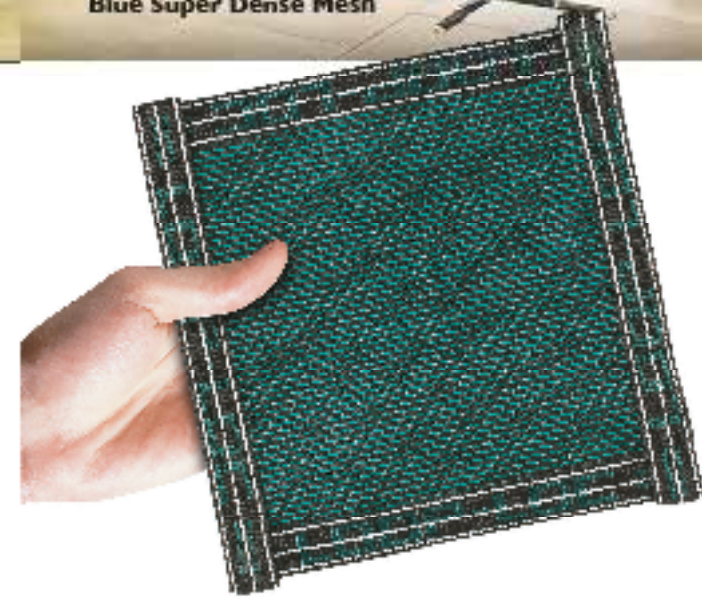

- Blocks virtually all sunlight
- Lets rain and melting snow easily drain through

SUPER DENSE MESH DESIGNER COLOR SERIES

[#AskForTheElephant](#)

PROTECT YOUR FAMILY WITH THE ONLY MESH
POOL COVER THAT PASSED THE ELEPHANT TEST.

You'll probably never need a pool cover safe and strong enough to support the weight of "Bubbles," the African elephant (seen on the cover). But imagine how safe you'll feel owning the only pool cover that's proven it can: the LOOP-LOC® Safety Swimming Pool Cover.



Gray Super Dense Mesh



Tan Super Dense Mesh

THERE'S ONLY ONE LOOP-LOC[®].

HERE ARE 15 REASONS WHY.

- 1 A LOOP-LOC cover is the only safety cover to be awarded UL certification year after year.
- 2 Mesh construction lets rain and melting snow drain right through.
- 3 LOOP-LOC is so durable, it's backed by a 15-year prorated warranty and so safe, it may reduce your liability insurance.
- 4 LOOP-LOC is so lightweight, putting it on and taking it off your pool is a snap.
- 5 LOOP-LOC blends beautifully into any backyard, with your choice of standard Spring Green or four optional designer colors.
- 6 LOOP-LOC's patented CABLE-LOC[™] and GAPGUARD[®] Child Safety Intrusion Barriers close the gap created when a pool includes raised obstructions located at the cover's edge.
- 7 The polyester bonded thread used in LOOP-LOC covers is 30% stronger in thread size and produces a higher margin of safety in all seams (compared to our competitors).
- 8 Double-perimeter webbing and double-thick straps give our covers an incredibly high break strength.
- 9 We use extremely high-strength, non-corrosive 302/304 grade stainless steel springs for superior weight-bearing capacity.
- 10 Unique brass anchors recess flush with the deck when the cover is removed.
- 11 We sew the webbing to the cover using contrasting white thread, instead of black, to ensure that not a single stitch is missed.
- 12 We use 87% black yarn in our fabric for superior UV stability.
- 13 Chafe strips are manufactured with exclusively virgin material - not "regrind," which tends to stain decking.
- 14 Non-corrosive aluminum tips are double-notched for stability.
- 15 The large X-tacking on LOOP-LOC straps is sewn manually for precise placement and maximum strength.



www.hxindia.com